

# Drapery Hardware Systems

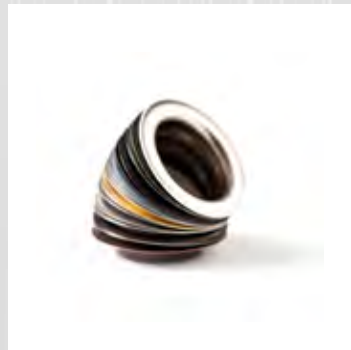

*AngBéjar*

Draperly Hardware Catalog 2022

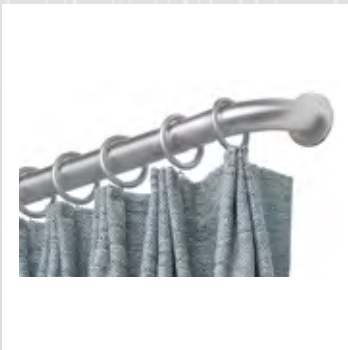

## Track Systems

# 3

B3 Series	04
D3 Series	06
B9 Series	08
N9 Series	09
E9 Series	10
DE9 Series	11
L9 Series	12
DL9 Series	13
Components	14
C6 Series	16
C7 Series	18
M6FX Series	20
M6SX Series	22
M6DX Series	<b>New!</b> 24
R3 Series	<b>New!</b> 26
R5 Series	28
R6 Series	30
R7 Series	<b>New!</b> 32
PS Series	34

## Decorative Rails

# 37

Urban Collection	38
Amsterdam Collection	40
Barcelona Collection	42
Munich Collection	44
Lyon Collection	46
Berlin Collection	48
Seine Collection	50
Porto Collection	52
Bonn Collection	53
Sofia Collection	54
Oxford Collection	56
Cannes Collection	58
Verona Collection	60
Liverpool Collection	62
Monaco Collection	64
Kiel Collection	66
Avalon Collection	68
Turin Collection	70
Brussels Collection	72
Budapest Collection	74
Dublin Collection	76
Galway Collection	<b>New!</b> 78
Vienna Collection	80
Lisboa Collection	82
Venecia Collection	84



## Decorative Pole Sets 87

Marseille Collection	88
Sevilla Collection	90
Paris Collection	92
Westport Collection	94
London Collection	96
Newcastle Collection	98
Milan Collection	100
Praha Collection	102
Frankfurt Collection	105
Rio Collection	<b>New!</b> 106
Oslo Collection	108
Essen Collection	110
Torino Collection	112
Beachfront Collection	114
Roma Collection	116
Toulouse Collection	118
Madrid Collection	120
Valencia Collection	122

## Other Products & Services 125

Fiberglass & Acrylic Batons	126
Aluminum Batons	127
Metal Batons	127
Wood Batons	127
Decorative Acrylic	127
Wood Holdbacks	128
Metal Holdbacks	128
Magnetic Tiebacks	129
Snap Tape	130
Grommets	131
Curves & Bends	132
Ripplefold Carrier Count	133



# Track Systems

*When European craftsmanship, sleek design and quiet performance are a **must**.* AngBéjar offers a wide range of track systems to fit every need and use.

We offer tracks for:

- Drapery Systems
- Cubicle Curtains
- Roman Shades
- Sliding Panels

Our high quality aluminum profiles can be custom curved or bent to almost any shape, giving you the functionality and aesthetic you want.

Built from quality European materials, our best-selling **B9 series** offer unparalleled lubrication and smooth movement.

Our Motorized **M6 series** features a silent motor, touch control, and the slimmest track on the motorized market.

From baton draw series to motorization, custom cuts and assembly, you are sure to find tracks that compliment your budget and décor.

AngBéjar

# B3 SERIES

## BATON TRACK



### PROFILE

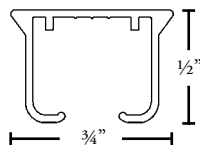

### AVAILABLE COLORS



WH

**B3TR13-WH**  
White Track 13' 1"  
**B3TR16-WH**  
White Track 16' 4"  
**B3TR19-WH**  
White Track 19' 8"  
\$4.04/ft.



SL



BK



BR

**B3TR16-SL** Silver Track 16' 4"  
**B3TR16-BK** Black Track 16' 4"  
**B3TR16-BR** Brown Track 16' 4"  
\$4.43/ft. 20 tracks/bundle

### PRODUCT INFORMATION

- Baton draw system
- Regular duty (6 lbs/ft.)
- Max length available in one piece: 236"
- Advanced aluminum extrusion
- Chromated powder coated with patented dry lubricant
- UV protected clickable carriers available
- Hassle-free installation with optional "Smart Klick" brackets
- Can be curved and bent (see p.118)
- Limited lifetime warranty

### STYLES

- Pinch pleat
- Ripplefold\*
- Cubicle
- FlexWave

### APPLICATIONS

- Center draw
- One-way draw
- Off-center draw

### ASSEMBLED PRICING

Includes: white track cut to size, masters, carriers, end caps, brackets and 36" fiberglass baton. \$107.75 for the first 4 ft. Each additional foot \$11.75. Freight not included. Add 10% for color other than white.

First 48"	60"	72"	84"	96"	108"	120"	132"
\$107.75	\$119.50	\$131.25	\$143.00	\$154.75	\$166.50	\$178.25	\$190.00
144"	156"	168"	180"	192"	204"	216"	228"
\$201.75	\$213.50	\$225.25	\$237.00	\$248.75	\$260.50	\$272.25	\$284.00

# COMPONENTS

## Carriers



**KCAR01-WH**  
Klick Carrier  
\$0.46 ea. 500/box



**SCAR04-WH**  
Snap Carrier  
\$0.48 ea. 500/box



**PCAR03-WH**  
Pinch Pleat Carrier  
\$0.26 ea. 2000/box



**BCAR04-WH**  
Small Ball Bearing  
\$1.19 ea. 100/box



**RCARS60-WH 60% Fullness**  
**RCARS80-WH 80% "**  
**RCARS100-WH 100% "**  
**RCARS120-WH 120% "**  
2 piece Connected Snap  
\$1.02 ea. 500/roll



**KCAR02-WH**  
Stop Carrier  
\$0.88 ea. 250/box



**HCAR06-WH**  
Carrier w/SS Hook  
\$1.25 ea. 100/box

## Masters



**PMAS525-WH** Over R  
**PMAS526-WH** Under L  
**PMAS527-WH** Over L  
**PMAS528-WH** Under R  
Pinch Pleat Masters  
\$10.94 ea. 25/box



**BMAS209-WH**  
Left Butt w/3 Snaps  
**BMAS210-WH**  
Right Butt w/3 Snaps  
\$14.97 ea. 15/box



**RMAS540-WH**  
Right Plastic Snap Master  
**RMAS541-WH**  
Left Plastic Snap Master  
\$6.12 ea. 20/box

## Brackets



**CBRA01-WH**  
Regular Duty Ceiling  
\$1.08 ea. 100/box



**CSPL901-WH**  
Ceiling Splice  
\$1.87 ea. 50/box



**CBRA02-WH**  
Klick On Ceiling Bracket  
\$1.36 ea. 100/box



**SPL905-WH**  
HD Splice w/4 screws  
\$8.56 ea. 10/box



**CBRA03-WH**  
HD Ceiling w/Klick  
\$1.87 ea. 100/box



**WBRA03-WH**  
3" Wall Bracket  
\$2.78 ea. 100/box



**WBRA06-WH**  
6" Double Wall Bracket  
\$4.59 ea. 50/box

## Other Components



**END309-WH**  
End Cap  
\$1.04 ea. 100/box



**END305-WH**  
Twist On End Stop  
\$1.84 ea. 100/box



**END307-SL**  
End Lock  
\$0.81 ea. 100/box



**RET308-WH**  
Return Plate  
\$7.14 ea. 100/box



For Batons see p.126

Add 10% for color other than white

For more information visit [www.angbejar.com](http://www.angbejar.com)

# D3 SERIES

## BATON TRACK

FlexWave Style



### PROFILE

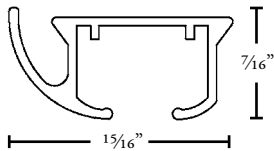

### AVAILABLE COLOR



**D3TR16-WH**  
White Track 16' 4"  
20 tracks/bundle  
\$6.32/ft.

### PRODUCT INFORMATION

- Elegant baton draw system with curved design fascia
- Regular duty (6 lbs/ft.)
- Max length available in one piece: 196"
- Advanced aluminum extrusion
- Chromated powder coated with patented dry lubricant
- UV protected clickable carriers available
- Hassle-free installation with optional "Smart Klick" brackets
- Can be curved and bent (see p.132)
- Limited lifetime warranty

### STYLES

- Pinch pleat
- Ripplefold\*
- Cubicle
- FlexWave

### APPLICATIONS

- Center draw
- One-way draw
- Off-center draw

### ASSEMBLED PRICING

Includes: track cut to size, masters, carriers, end caps, brackets and 36" fiberglass baton. \$111.75 for the first 4 ft. Each additional foot \$13.00. Freight not included.

First 48"	60"	72"	84"	96"	108"	120"	132"
\$111.75	\$124.75	\$137.75	\$150.75	\$163.75	\$176.75	\$189.75	\$202.75
144"	156"	168"	180"	192"	204"	216"	228"
\$215.75	\$228.75	\$241.75	\$254.75	\$267.75	\$280.75	\$293.75	\$306.75



# COMPONENTS

## Carriers



**KCAR01-WH**  
Klick Carrier  
\$0.46 ea. 500/box



**SCAR04-WH**  
Snap Carrier  
\$0.48 ea. 500/box



**RCARS60-WH** 60% Fullness  
**RCARS80-WH** 80%   "  
**RCARS100-WH** 100%   "  
**RCARS120-WH** 120%   "  
2 piece Connected Snap  
\$1.02 ea. 500/roll



**BCAR04-WH**  
Small Ball Bearing  
\$1.19 ea. 100/box



**PCAR03-WH**  
Pinch Pleat Carrier  
\$0.26 ea. 2000/box



**KCAR02-WH**  
Stop Carrier  
\$0.88 ea. 250/box



**HCAR06-WH**  
Carrier w/SS Hook  
\$1.25 ea. 100/box

## Masters



**PMAS525-WH** Over R  
**PMAS526-WH** Under L  
**PMAS527-WH** Over L  
**PMAS528-WH** Under R  
Pinch Pleat Masters  
\$10.94 ea. 25/box



**BMAS209-WH**  
Left Butt w/3 Snaps  
**BMAS210-WH**  
Right Butt w/3 Snaps  
\$14.97 ea. 15/box



**RMAS540-WH**  
Right Plastic Snap Master  
**RMAS541-WH**  
Left Plastic Snap Master  
\$6.12 ea. 20/box



**CBRA01-WH**  
Regular Duty Ceiling  
\$1.08 ea. 100/box



**CSPL901-WH**  
Ceiling Splice  
\$1.87 ea. 50/box



**CBRA02-WH**  
Klick On Ceiling Bracket  
\$1.36 ea. 100/box



**SPL905-WH**  
HD Splice w/4 screws  
\$8.56 ea. 10/box



**CBRA03-WH**  
HD Ceiling w/Klick  
\$1.87 ea. 100/box



**WBRA03-WH**  
3" Wall Bracket  
\$2.78 ea. 100/box



**WBRA06-WH**  
6" Double Wall Bracket  
\$4.59 ea. 50/box

## Other Components



**END305-WH**  
Twist On End Stop  
\$1.84 ea. 100/box



**END310-WH**  
End Cap w/Screw  
\$1.84 ea. 10/box



**WST01-WH**  
Wave Stop  
\$0.74 ea.



For Batons see p.126

For more information visit [www.angbejar.com](http://www.angbejar.com)

# B9 SERIES

## BATON TRACK



### PROFILE

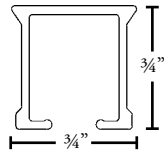

### AVAILABLE COLORS



WH

**B9TR12-WH**  
White Track 12'  
**B9TR14-WH**  
White Track 14'  
**B9TR16-WH**  
White Track 16'  
**B9TR20-WH**  
White Track 20'  
\$3.38/ft.



SL



BR



BK

**B9TR16-SL** Silver Track 16'  
**B9TR16-BR** Brown Track 16'  
**B9TR16-BK** Black Track 16'  
\$3.72/ft. 20 tracks/bundle

See components on p. 14

### PRODUCT INFORMATION

- Baton draw system
- Heavy-contract duty (9 lbs/ft.)
- Max length available in one piece: 240"
- Advanced aluminum extrusion
- Chromated powder coated with patented dry lubricant
- Heavy duty ball bearing carriers for smooth operation
- Hassle-free installation with optional "Smart Klick" brackets
- Can be curved and bent (see p.132)
- Limited lifetime warranty

### STYLES

- Pinch pleat
- Ripplefold\*
- Cubicle
- FlexWave

### APPLICATIONS

- Center draw
- One-way draw
- Off-center draw

### ASSEMBLED PRICING

Includes: white track cut to size, masters, carriers, end caps, brackets and 36" fiberglass baton. \$124.25 for the first 4 ft. Each additional foot \$10.50. Freight not included. Add 10% for color other than white.

First 48"	60"	72"	84"	96"	108"	120"	132"
\$124.25	\$134.75	\$145.25	\$155.75	\$166.25	\$176.75	\$187.25	\$197.75
144"	156"	168"	180"	192"	204"	216"	228"
\$208.25	\$218.75	\$229.25	\$239.75	\$250.25	\$260.75	\$271.25	\$281.75

Add 10% for color other than white

# N9 SERIES

## BATON TRACK



### PROFILE

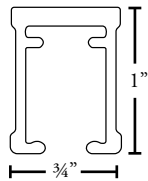

### AVAILABLE COLORS



**N9TR16-WH**  
White Track 16'  
\$8.62/ft.

See components on p. 14

### PRODUCT INFORMATION

- Baton draw system for ceiling installation
- Heavy-contract duty (9 lbs/ft.)
- Max length available in one piece: 192"
- Advanced aluminum extrusion
- Powder coated
- Heavy duty ball bearing carriers for smooth operation
- Hassle-free ceiling installation without brackets
- Cannot be curved nor bent
- Limited lifetime warranty

### STYLES

- Pinch pleat
- Ripplefold\*
- Cubicle
- FlexWave

### APPLICATIONS

- Center draw
- One-way draw
- Off-center draw

### ASSEMBLED PRICING

Includes: track cut to size, masters, carriers, end caps, brackets and 36" fiberglass baton. \$157.75 for the first 4 ft. Each additional foot \$14.25. Freight not included.

First 48"	60"	72"	84"	96"	108"	120"	132"
\$157.75	\$172.00	\$186.25	\$200.50	\$214.75	\$229.00	\$243.25	\$257.50
144"	156"	168"	180"	192"	204"	216"	228"
\$271.75	\$286.00	\$300.25	\$314.50	\$328.75	\$343.00	\$357.25	\$371.50

For more information visit [www.angbejar.com](http://www.angbejar.com)

# E9 SERIES

## BATON TRACK



### PROFILE

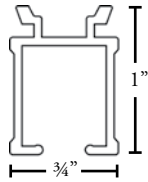

### AVAILABLE COLORS



WH

**E9TR12-WH**  
White Track 12'  
**E9TR14-WH**  
White Track 14'  
**E9TR16-WH**  
White Track 16'  
**E9TR18-WH**  
White Track 18'  
\$3.67/ft.



SL



BK

**E9TR16-SL** Silver Track 16'  
**E9TR16-BK** Black Track 16'  
\$4.88/ft. 20 tracks/bundle

See components on p. 14

### PRODUCT INFORMATION

- Baton draw system
- Heavy-contract duty (9 lbs/ft.)
- Max length available in one piece: 216"
- Advanced aluminum extrusion
- Chromated powder coated and lubricated
- Heavy duty ball bearing carriers for smooth operation
- Hassle-free installation with Cam Lock brackets
- Cannot be curved nor bent
- Limited lifetime warranty

### STYLES

- Pinch pleat
- Ripplefold\*
- Cubicle
- FlexWave

### APPLICATIONS

- Center draw
- One-way draw
- Off-center draw

### ASSEMBLED PRICING

Includes: white track cut to size, masters, carriers, end caps, brackets and 36" fiberglass baton. \$128.25 for the first 4 ft. Each additional foot \$11.00. Freight not included. Add 10% for color other than white.

First 48"	60"	72"	84"	96"	108"	120"	132"
\$128.25	\$139.25	\$150.25	\$161.25	\$172.25	\$183.25	\$194.25	\$205.25
144"	156"	168"	180"	192"	204"	216"	228"
\$216.25	\$227.25	\$238.25	\$249.25	\$260.25	\$271.25	\$282.25	\$293.25

Add 10% for color other than white

# DE9 SERIES

## BATON TRACK



### PROFILE

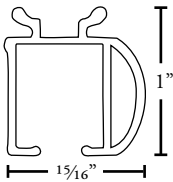

### AVAILABLE COLORS



WH

**DE9TR16-WH**  
White Track 16'  
\$7.09/ft.



SL



BK

**DE9TR16-SL** Silver Track 16'  
**DE9TR16-BK** Black Track 16'  
\$8.22/ft. 20 tracks/bundle

See components on p. 14

### PRODUCT INFORMATION

- Baton draw system with curved design fascia
- Heavy-contract duty (9 lbs/ft.)
- Max length available in one piece: 192"
- Advanced aluminum extrusion
- Chromated powder coated and lubricated
- Heavy duty ball bearing carriers for smooth operation
- Cannot be curved nor bent
- Limited lifetime warranty

### STYLES

- Pinch pleat
- Ripplefold\*
- Cubicle
- FlexWave

### APPLICATIONS

- Center draw
- One-way draw
- Off-center draw

### ASSEMBLED PRICING

Includes: white track cut to size, masters, carriers, end caps, brackets and 36" fiberglass baton. \$153.75 for the first 4 ft. Each additional foot \$14.50. Freight not included. Add 10% for color other than white.

First 48"	60"	72"	84"	96"	108"	120"	132"
\$153.75	\$168.25	\$182.75	\$197.25	\$211.75	\$226.25	\$240.75	\$255.25
144"	156"	168"	180"	192"	204"	216"	228"
\$269.75	\$284.25	\$298.75	\$313.25	\$327.75	\$342.25	\$356.75	\$371.25

Add 10% for color other than white

For more information visit [www.angbejar.com](http://www.angbejar.com)

# L9 SERIES

## BATON TRACK



### PROFILE

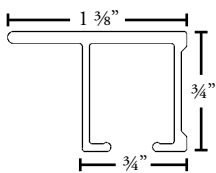

### AVAILABLE COLORS



WH

**L9TR12-WH**  
White Track 12'  
**L9TR14-WH**  
White Track 14'  
**L9TR16-WH**  
White Track 16'  
**L9TR18-WH**  
White Track 18'  
\$3.72/ft.



SL



BK

**L9TR16-SL** Silver Track 16'  
**L9TR16-BK** Black Track 16'  
\$5.33/ft. 20 tracks/bundle

See components on p. 14

### PRODUCT INFORMATION

- Baton draw system for ceiling installation
- Heavy-contract duty (9 lbs/ft.)
- Max length available in one piece: 216"
- Advanced aluminum extrusion
- Chromated powder coated and lubricated
- Heavy duty ball bearing carriers for smooth operation
- Hassle-free ceiling installation without brackets
- Cannot be curved nor bent
- Limited lifetime warranty

### STYLES

- Pinch pleat
- Ripplefold\*
- Cubicle
- FlexWave

### APPLICATIONS

- Center draw
- One-way draw
- Off-center draw

### ASSEMBLED PRICING

Includes: white track cut to size, masters, carriers, end caps, brackets and 36" fiberglass baton. \$111.50 for the first 4 ft. Each additional foot \$9.50. Freight not included. Add 10% for color other than white.

First 48"	60"	72"	84"	96"	108"	120"	132"
\$111.50	\$121.00	\$130.50	\$140.00	\$149.50	\$159.00	\$168.50	\$178.00
144"	156"	168"	180"	192"	204"	216"	228"
\$187.50	\$197.00	\$206.50	\$216.00	\$225.50	\$235.00	\$244.50	\$254.00

Add 10% for color other than white

# DL9 SERIES

## BATON TRACK



### PROFILE

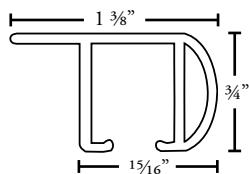

### AVAILABLE COLORS



WH

**DL9TR16-WH**  
White Track 16'  
\$7.77/ft.



SL



BK

**DL9TR16-SL** Silver Track 16'  
**DL9TR16-BK** Black Track 16'  
\$8.79/ft. 20 tracks/bundle

See components on p. 14

### PRODUCT INFORMATION

- Baton draw system with curved design fascia for ceiling installation
- Heavy-contract duty (9 lbs/ft.)
- Max length available in one piece: 192"
- Advanced aluminum extrusion
- Chromated powder coated and lubricated
- Heavy duty ball bearing carriers for smooth operation
- Hassle-free ceiling installation without brackets
- Cannot be curved nor bent
- Limited lifetime warranty

### STYLES

- Pinch pleat
- Ripplefold\*
- Cubicle
- FlexWave

### APPLICATIONS

- Center draw
- One-way draw
- Off-center draw

### ASSEMBLED PRICING

Includes: white track cut to size, masters, carriers, end caps, brackets and 36" fiberglass baton. \$153.75 for the first 4 ft. Each additional foot \$14.25. Freight not included. Add 10% for color other than white.

First 48"	60"	72"	84"	96"	108"	120"	132"
\$153.75	\$168.00	\$182.25	\$196.50	\$210.75	\$225.00	\$239.25	\$253.50
144"	156"	168"	180"	192"	204"	216"	228"
\$267.75	\$282.00	\$296.25	\$310.50	\$324.75	\$339.00	\$353.25	\$367.50

Add 10% for color other than white

For more information visit [www.angbejar.com](http://www.angbejar.com)

# COMPONENTS FOR B9, N9, E9, DE9, L9 & DL9 SERIES

## Carriers



**RCARW60-WH** 60% Fullness  
**RCARW80-WH** 80%   "  
**RCARW100-WH** 100%   "  
**RCARW120-WH** 120%   "  
 Wheeled Connected Snap  
 \$1.25 ea. 500/roll



**RCARS60-WH** 60% Fullness  
**RCARS80-WH** 80%   "  
**RCARS100-WH** 100%   "  
**RCARS120-WH** 120%   "  
 2 piece Connected Snap  
 \$1.02 ea. 500/roll



**RCARB60-WH** 60% Fullness  
**RCARB80-WH** 80%   "  
**RCARB100-WH** 100%   "  
**RCARB120-WH** 120%   "  
 B/B Connected Snap  
 \$1.65 ea.



**SCAR04-WH**  
 Snap Carrier  
 \$0.48 ea. 500/box



**PCAR03-WH**  
 Pinch Pleat Carrier  
 \$0.26 ea. 2000/box



**BCAR02-WH**  
 Slim Ball Bearing  
 \$0.58 ea. 1000/box



**BCAR05-WH**  
 Ball Bearing w/SS Hook  
 \$1.59 ea. 1000/box



**KCAR08-WH**  
 Slim Line Klick  
 \$0.85 ea. 200/bag



**END305-WH**  
 Twist On End Stop  
 \$1.84 ea. 100/box

## Masters



**RMAS301-WH** Over R  
**RMAS302-WH** Under L  
 Ripplefold Master w/  
 Snaps and Adaptor  
 \$7.60 ea. 100/box



**PMAS101-WH** Over R  
**PMAS102-WH** Under L  
 Pinch Pleat Master  
 Multifunctional  
 \$6.01 ea. 100/box



**RMAS305-WH** Over R  
**RMAS306-WH** Under L  
 Ripplefold Multifunctional  
 Master NO snaps  
 \$6.26 ea. 100/box



**PMAS103-WH** Over R  
**PMAS104-WH** Under L  
 Pinch Pleat Master for  
 Stiffeners only  
 \$6.01 ea. 100/box



**BMAS209-WH** Left  
**BMAS210-WH** Right  
 Butt w/3 Snaps  
 \$14.97 ea 15/box



**BMAS403-WH** Right  
**BMAS404-WH** Left  
 Wheeled Butt Master  
 \$26.93 ea. 15/box



**BMAS401-WH** Right  
**BMAS402-WH** Left  
 2-piece Butt Master  
 \$22.75 ea.



**PMAS108-WH** Over R  
**PMAS109-WH** Under L  
 Master to be used with  
 Curves and Bends  
 \$11.00 ea. 15/box



## Brackets for B9 Series



**CBRA01-WH**  
Regular Duty Ceiling  
\$1.08 ea. 100/box



**CSPL901-WH**  
Ceiling Splice  
\$1.87 ea. 50/box



**CBRA02-WH**  
Klick On Ceiling Bracket  
\$1.36 ea. 100/box



**CBRA03-WH**  
HD Ceiling w/Klick  
\$1.87 ea. 100/box



**SPL903-WH**  
HD Splice w/4 Screws  
\$16.05 ea. 50/box



**WBRA03-WH**  
3" Wall Bracket  
\$2.78 ea. 100/box



**WBRA06-WH**  
6" Double Wall Bracket  
\$4.59 ea. 50/box

## Brackets for E9 and DE9 Series



**ECBR01-WH**  
Ceiling Bracket CamLock  
\$1.39 ea. 100/box



**EWR03-WH**  
3" Wall Bracket with  
metal CamLock  
\$3.67 ea. 100/box



**EWR06-WH**  
6" Double Wall Bracket  
with metal CamLock  
\$4.54 ea. 50/box



**SPL907-SL**  
Splice w/Screws  
\$16.16 ea.

## Other Components



**END301-WH**  
End Cap w/Slide  
\$1.01 ea. 400/box



**END302-WH** Right  
**END303-WH** Left  
End Cap w/Return Plate  
\$1.95 ea. 100/box



**END307-SL**  
End Lock  
\$0.81 ea. 100/box



**RET309-WH** Left  
**RET310-WH** Right  
Plastic 2" Return  
\$4.88 ea. 100/box



**RET308-WH**  
Metal Return Plate  
\$7.14 ea.

Add 10% for color other than white

For more information visit [www.angbejar.com](http://www.angbejar.com)

# C6 SERIES

## CORDED TRACK



### PROFILE

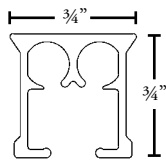

### AVAILABLE COLORS



WH

**C6TR12-WH**  
White Track 12'  
**C6TR14-WH**  
White Track 14'  
**C6TR16-WH**  
White Track 16'  
**C6TR20-WH**  
White Track 20'  
\$5.26/ft.



SL



BR



BK

**C6TR16-SL** Silver Track 16'  
**C6TR16-BR** Brown Track 16'  
**C6TR16-BK** Black Track 16'  
\$5.78/ft. 20 tracks/bundle

### PRODUCT INFORMATION

- Cord draw system
- Heavy-contract duty (6 lbs/ft.)
- Max length available in one piece: 242" (white color)
- Advanced aluminum extrusion
- Chromated powder coated with patented dry lubricant
- UV protected heavy duty clickable carriers available
- Hassle-free installation with optional "Smart Klick" brackets
- Can be curved and bent (see p.132)
- Limited lifetime warranty

### STYLES

- Pinch pleat
- Ripplefold\*
- FlexWave

### APPLICATIONS

- Center draw
- One-way draw

### ASSEMBLED PRICING

Includes: white track cut to size, masters, carriers, end pulleys, cord and brackets. \$189.50 for the first 4 ft. Each additional foot \$16.00. Freight not included. Add 10% for color other than white.

First 48"	60"	72"	84"	96"	108"	120"	132"
\$189.50	\$205.50	\$221.50	\$237.50	\$253.50	\$269.50	\$285.50	\$301.50
144"	156"	168"	180"	192"	204"	216"	228"
\$317.50	\$333.50	\$349.50	\$365.50	\$381.50	\$397.50	\$413.50	\$429.50

# COMPONENTS

## Carriers



**PCAR03-WH**  
Pinch Pleat Carrier  
\$0.26 ea. 2000/box



**KCAR08-WH**  
Slim Line Klick  
\$0.85 ea. 200/bag



**BCAR04-WH**  
Small Ball Bearing  
\$1.19 ea. 100/box



**RCARS60-WH** 60% Fullness  
**RCARS80-WH** 80% ”  
**RCARS100-WH** 100% ”  
**RCARS120-WH** 120% ”  
2 piece Connected Snap  
\$1.02 ea. 500/roll



**END305-WH**  
Twist On End Stop  
\$1.84 ea. 100/box

## Masters



**PMAS108-WH** Over R  
**PMAS109-WH** Under L  
Cord Master to be used  
with Bends and Curves  
\$11.00 ea. 15/box



**RMAS308-WH** Over R  
**RMAS309-WH** Under L  
Cord Master w/Snaps  
\$13.27 ea. 15/box



**BMAS209-WH**  
Left Butt w/3 Snaps  
**BMAS210-WH**  
Right Butt w/3 Snaps  
\$14.97 ea. 15/box

## Brackets



**CBRA01-WH**  
Regular Duty Ceiling  
\$1.08 ea. 100/box



**CSPL901-WH**  
Ceiling Splice  
\$1.87 ea. 50/box



**CBRA02-WH**  
Klick On Ceiling Bracket  
\$1.36 ea. 100/box



**CBRA03-WH**  
HD Ceiling w/Klick  
\$1.87 ea. 100/box



**WBRA03-WH**  
3" Wall Bracket  
\$2.78 ea. 100/box

## Other Components



**WBRA06-WH**  
6" Double Wall Bracket  
\$4.59 ea. 50/box



**SPL903-WH**  
HD Splice w/4 screws  
\$16.05 ea. 50/box



**C6RT01-WH**  
Return Insert w/ Snap  
\$5.28 ea. 25/box



**C6EN01-WH**  
End Pulley  
\$9.64 ea. 25/box



**C6EN02-WH** Right  
**C6EN04-WH** Left  
End Pulley w/Snap  
\$10.55 ea. 25/box



**C6EN03-WH**  
Small End Pulley  
\$9.64 ea. 25/box



**C6CON10-WH**  
Cord Connector  
\$1.98 ea. 100/box



**COR01-WH**  
3.3mm Non-stretch Cord  
\$1.58/yd. 273.4 yds/roll



**CTEN01-WH**  
Tension Device  
\$4.07 ea.



**CTEN04-WH**  
Child Safety Tension  
Device  
\$7.43 ea.

Add 10% for color other than white

For more information visit [www.angbejar.com](http://www.angbejar.com)

# C7 SERIES

## HEAVY DUTY CORDED TRACK



### PROFILE

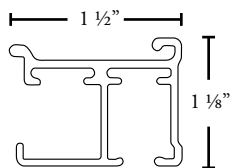

### AVAILABLE COLORS



**C7TR16-WH**  
White Track 16'  
\$10.66/ft.



BR



BK

**C7TR16-XX**  
C7 Track 16'  
\$12.25/ft.

### PRODUCT INFORMATION

- Cord draw system
- Heavy-contract duty (10 lbs/ft.)
- Max length available in one piece: 192"
- Advanced aluminum extrusion
- Powder coated aluminum
- Cannot be curved nor bent
- Limited lifetime warranty

### STYLES

- Pinch pleat
- Ripplefold\*

### APPLICATIONS

- Center draw
- One-way draw

### ASSEMBLED PRICING

Includes: track cut to size, masters, carriers, end pulleys, tension pulley, cord and brackets. \$231.00 for the first 4 ft. Each additional foot \$20.75. Freight not included.

First 48"	60"	72"	84"	96"	108"	120"	132"
\$231.00	\$251.75	\$272.50	\$293.25	\$314.00	\$334.75	\$355.50	\$376.25
144"	156"	168"	180"	192"	204"	216"	228"
\$397.00	\$417.75	\$438.50	\$459.25	\$480.00	\$500.75	\$521.50	\$542.25

## COMPONENTS

### Carriers



**BCAR02-WH**  
Slim Ball Bearing  
\$0.58 ea. 1000/box



**RCARW60-WH 60% Fullness**  
**RCARW80-WH 80% ”**  
**RCARW100-WH 100% ”**  
**RCARW120-WH 120% ”**  
Wheeled Connected Snap  
\$1.25 ea. 500/roll

### Masters



**C7PMO-WH**  
Overlap Master for  
Pinch Pleat  
\$18.60 ea.



**C7PMU-WH**  
Underlap Master for  
Pinch Pleat  
\$18.60 ea.



**C7RMO-WH**  
Overlap Master for  
Ripplefold  
\$21.38 ea.



**C7RMU-WH**  
Underlap Master for  
Ripplefold  
\$21.38 ea.

### Brackets



**C7CB01-WH**  
C7 HD Ceiling Bracket  
\$11.74 ea.

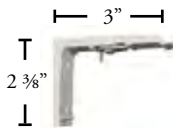

**C7WB03-WH**  
C7 HD Single Wall Bracket  
\$18.03 ea.

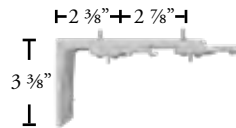

**C7WB06-WH**  
C7 HD Double Wall  
Bracket  
\$38.67 ea.

### Other Components



**COR01-WH**  
3.3mm Non-stretch Cord  
\$1.58/yd. 273.4 yds/roll



**CTEN01-WH**  
Tension Device  
\$4.07 ea.



**CTEN04-WH**  
Child Safety Tension  
Device  
\$7.43 ea.

For more information visit [www.angbejar.com](http://www.angbejar.com)

# M6FX SERIES

## MOTORIZED TRACK

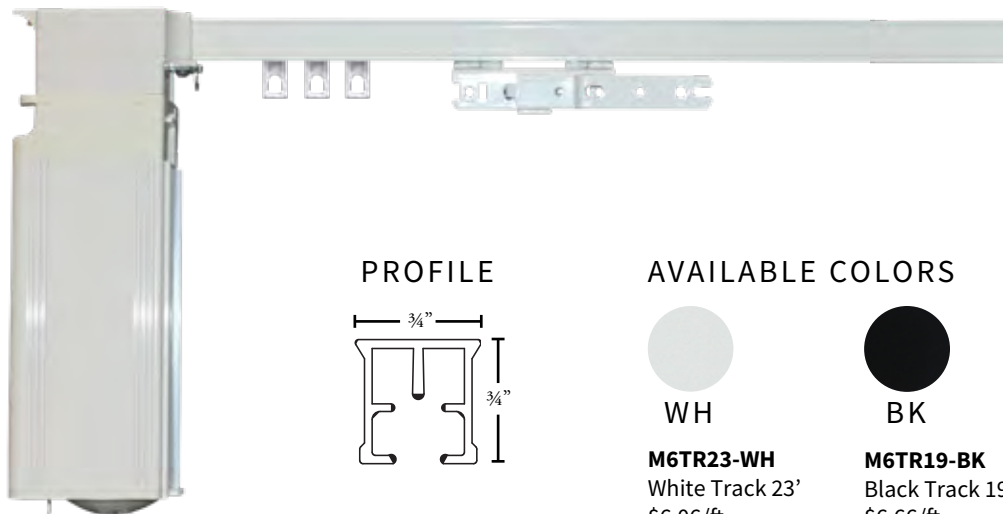

### PROFILE

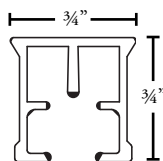

### AVAILABLE COLORS



WH

**M6TR23-WH**  
White Track 23'  
\$6.06/ft.



BK

**M6TR19-BK**  
Black Track 19'  
\$6.66/ft.

### STYLES

- Pinch pleat
- Ripplefold\*
- FlexWave

### APPLICATIONS

- Center draw
- One-way draw

### PRODUCT INFORMATION

- Ultra silent motorized system with Touch Impulse Technology.
- Automatic setting of limits
- Programmable stack-back position
- Smart radio frequency control (more control options available)
- 24 volt DC power input using “Plug & Play” 115 volt AC adaptor
- Motor “S” class drapery weight capacity up to 100 lbs.
- HD Motor “M” class drapery weight capacity up to 160 lbs. on straight track
- Max length available in one piece: 280”
- Chromated powder coated with patented dry lubricant
- UV protected, heavy duty clickable carriers available
- Hassle-free installation with optional “Smart Klick” brackets
- Can be curved and bent (see p.132)
- Home automation compatible
- Limited 10-year warranty

### Controls



**RFC15-WH**  
RF Multi Remote 15 ch.  
\$368.59 ea.



**RFW02-WH**  
RF Wireless Wall Switch  
with 2 Channels  
\$181.42 ea.



**RFW16-WH**  
RF Wireless Wall Switch  
15 Channels w/timer  
\$317.12 ea.



**BEXPRO-WH**  
Smart IP Bridge  
for automation

## ASSEMBLED PRICING

### “S” CLASS MOTOR (100 LBS MAX) \*

Includes: white track cut to size and assembled, “S” class motor, RF remote and power supply. \$1,808.75 for the first 4 ft. Each additional foot \$31.25. Freight not included. Other components at an additional cost.

First 48"	60"	72"	84"	96"	108"	120"	132"
\$1,808.75	\$1,840.00	\$1,871.25	\$1,902.50	\$1,933.75	\$1,965.00	\$1,996.25	\$2,027.50
144"	156"	168"	180"	192"	204"	216"	228"
\$2,058.75	\$2,090.00	\$2,121.25	\$2,152.50	\$2,183.75	\$2,215.00	\$2,246.25	\$2,277.50

### “M” CLASS MOTOR (160 LBS MAX) \*

Includes: white track cut to size and assembled, “M” class motor, RF remote and power supply. \$2,024.25 for the first 4 ft. Each additional foot \$31.25. Freight not included. Other components at an additional cost.

First 48"	60"	72"	84"	96"	108"	120"	132"
\$2,024.25	\$2,055.50	\$2,086.75	\$2,118.00	\$2,149.25	\$2,180.50	\$2,211.75	\$2,243.00
144"	156"	168"	180"	192"	204"	216"	228"
\$2,274.25	\$2,305.50	\$2,336.75	\$2,368.00	\$2,399.25	\$2,430.50	\$2,461.75	\$2,493.00

\* Make it compatible with Somfy Controls adding a M6RTS02 Receiver for \$495.00

### “I” CLASS MOTOR (RECHARGABLE BATTERY)

Includes: white track cut to size and assembled, “I” class motor, RF remote and power supply. \$2,005.25 for the first 4 ft. Each additional foot \$31.25. Freight not included. Other components at an additional cost.

First 48"	60"	72"	84"	96"	108"	120"	132"
\$2,005.25	\$2,036.50	\$2,067.75	\$2,099.00	\$2,130.25	\$2,161.50	\$2,192.75	\$2,224.00
144"	156"	168"	180"	192"	204"	216"	228"
\$2,255.25	\$2,286.50	\$2,317.75	\$2,349.00	\$2,380.25	\$2,411.50	\$2,442.75	\$2,474.00

## Motors



**M6S939-WH**  
“S” Class Motor  
\$920.27 ea.



**M6M927-WH**  
“M” Class Motor  
\$1,136.17 ea.



**M6I926-WH**  
“I” Class Motor  
\$1,129.92 ea.

Add 10% for color other than white

For more information visit [www.angbejar.com](http://www.angbejar.com)

# M6SX SERIES

## MOTORIZED TRACK

### PROFILE

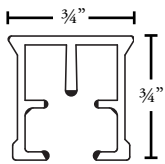

### AVAILABLE COLORS



WH

**M6TR23-WH**  
White Track 23'  
\$6.06/ft.



BK

**M6TR19-BK** Black Track 19'  
**M6TR19-SL** Silver Track 19'  
\$6.66/ft.



SL

### STYLES

- Pinch pleat
- Ripplefold\*
- FlexWave

### APPLICATIONS

- Center draw
- One-way draw

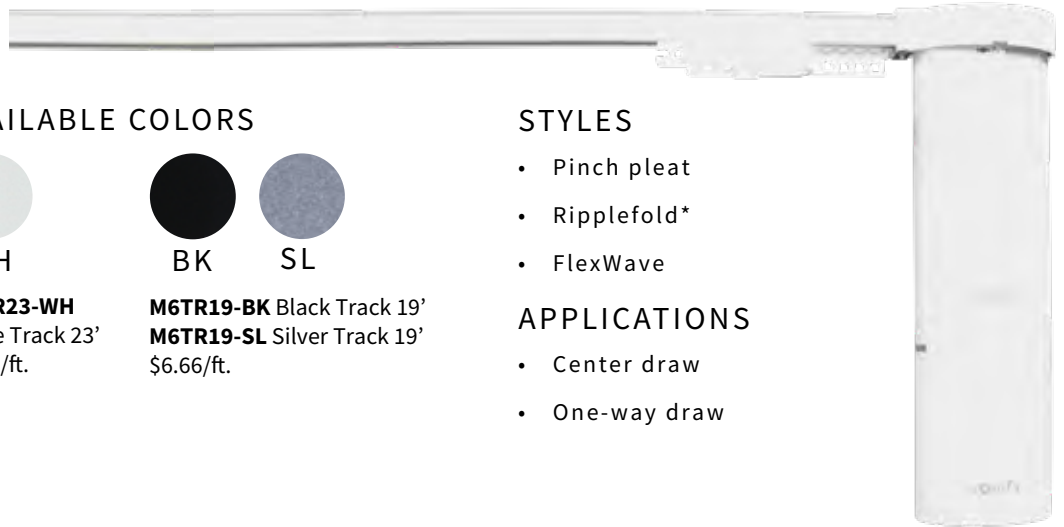

## PRODUCT INFORMATION

- Ultra silent motorized system with Touch Impulse Technology.
- Automatic setting of limits
- Programmable stack-back position
- Smart radio frequency control (more control options available)
- Motor Ultra 30 Class weight capacity up to 66 lbs.
- HD Motor Ultra 60 Class weight capacity up to 132 lbs. on straight track
- Battery Motor I-45 Class Lithium Battery weight capacity up to 99 lbs.
- Max length available in one piece: 280"
- Chromated powder coated with patented dry lubricant
- UV protected, heavy duty clickable carriers available
- Hassle-free installation with optional "Smart Klick" brackets
- Can be curved and bent (see p.132)
- Home automation compatible
- Limited 5-year warranty

## Controls



**RCS04-WH**  
RTS Multi Remote  
Control 4 ch.  
\$253.45 ea.



**RCS01-WH**  
RTS Remote  
Control 1 ch.  
\$238.30 ea.



**RCS05-WH**  
RTS Situo Remote  
Control 5 ch.  
\$299.65 ea.



**BEXPRO-WH**  
Smart IP Bridge  
for automation



## ASSEMBLED PRICING

### SOMFY “ULTRA 30” CLASS MOTOR (66 LBS MAX)

Includes: white track cut to size and assembled, “Ultra 30” class motor, RF remote and power supply. \$2,125.75 for the first 4 ft. Each additional foot \$31.25. Freight not included. Other components at an additional cost.

First 48”	60”	72”	84”	96”	108”	120”	132”
\$2,125.75	\$2,157.00	\$2,188.25	\$2,219.50	\$2,250.75	\$2,282.00	\$2,313.25	\$2,344.50
144”	156”	168”	180”	192”	204”	216”	228”
\$2,375.75	\$2,407.00	\$2,438.25	\$2,469.50	\$2,500.75	\$2,532.00	\$2,563.25	\$2,594.50

### SOMFY “ULTRA 60” CLASS MOTOR (132 LBS MAX)

Includes: white track cut to size and assembled, “Ultra 60” class motor, RF remote and power supply. \$2,540.50 for the first 4 ft. Each additional foot \$31.25. Freight not included. Other components at an additional cost.

First 48”	60”	72”	84”	96”	108”	120”	132”
\$2,540.50	\$2,571.75	\$2,603.00	\$2,634.25	\$2,665.50	\$2,696.75	\$2,728.00	\$2,759.25
144”	156”	168”	180”	192”	204”	216”	228”
\$2,790.50	\$2,821.75	\$2,853.00	\$2,884.25	\$2,915.50	\$2,946.75	\$2,978.00	\$3,009.25

### SOMFY “I-45” CLASS BATTERY MOTOR (99 LBS MAX)

Includes: white track cut to size and assembled, “I-45” class motor, RF remote and power supply. \$2,455.25 for the first 4 ft. Each additional foot \$31.25. Freight not included. Other components at an additional cost.

First 48”	60”	72”	84”	96”	108”	120”	132”
\$2,455.25	\$2,486.50	\$2,517.75	\$2,549.00	\$2,580.25	\$2,611.50	\$2,642.75	\$2,674.00
144”	156”	168”	180”	192”	204”	216”	228”
\$2,705.25	\$2,736.50	\$2,767.75	\$2,799.00	\$2,830.25	\$2,861.50	\$2,892.75	\$2,924.00

#### Motors



**SGLY30-WH**  
“Ultra 30” Class Motor



**SGLY60-WH**  
“Ultra 60” Class Motor



**SIR45-WH**  
“I-45” Class Battery Motor

Add 10% for color other than white

For more information visit [www.angbejar.com](http://www.angbejar.com)

# M6DX SERIES

## MOTORIZED TRACK

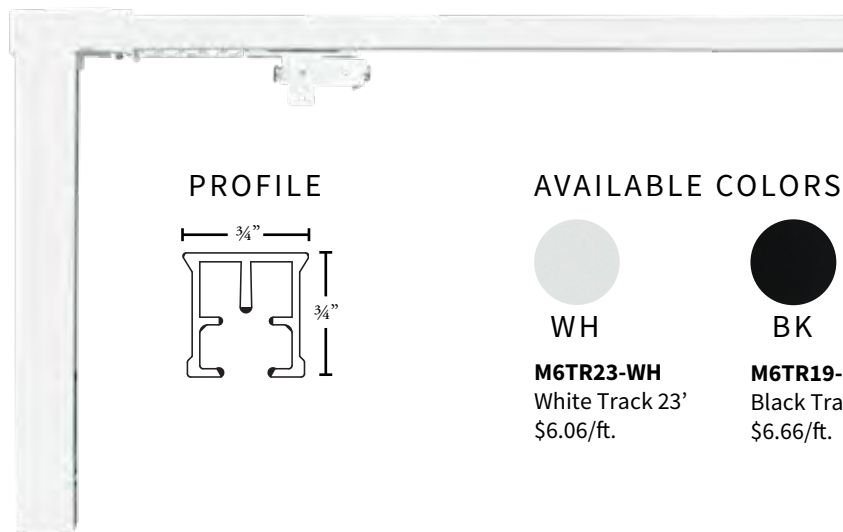

### PRODUCT INFORMATION

- Ultra silent motorized system with Touch Impulse Technology.
- Automatic setting of limits
- Programmable stack-back position
- Smart radio frequency control (more control options available)
- 24 volt DC power input using “Plug & Play” 115 volt AC adaptor
- Motor D1 class drapery weight capacity up to 75 lbs.
- Motor D3-W class drapery weight capacity up to 50 lbs. on straight track
- Max length available in one piece: 280”
- Chromated powder coated with patented dry lubricant
- UV protected, heavy duty clickable carriers available

- Hassle-free installation with optional “Smart Klick” brackets
- Can be curved and bent (see p.132)
- Home automation compatible
- Limited 5-year warranty

### STYLES

- Pinch pleat
- Ripplefold\*
- FlexWave

### APPLICATIONS

- Center draw
- One-way draw

## ASSEMBLED PRICING

### “D1” CLASS MOTOR (75 LBS MAX)

Includes: white track cut to size and assembled, “D1” class motor, RF remote and power supply. \$1,725.00 for the first 4 ft. Each additional foot \$31.25. Freight not included. Other components at an additional cost.

First 48”	60”	72”	84”	96”	108”	120”	132”
\$1,725.00	\$1,756.25	\$1,787.50	\$1,818.75	\$1,850.00	\$1,881.25	\$1,912.50	\$1,943.75
144”	156”	168”	180”	192”	204”	216”	228”
\$1,975.00	\$2,006.25	\$2,037.50	\$2,068.75	\$2,100.00	\$2,131.25	\$2,162.50	\$2,193.75

### “D3” CLASS BATTERY MOTOR (50 LBS MAX)

Includes: white track cut to size and assembled, “D3” class battery motor, and RF remote. \$1,940.75 for the first 4 ft. Each additional foot \$31.25. Freight not included. Other components at an additional cost.

First 48”	60”	72”	84”	96”	108”	120”	132”
\$1,940.75	\$1,972.00	\$2,003.25	\$2,034.50	\$2,065.75	\$2,097.00	\$2,128.25	\$2,159.50
144”	156”	168”	180”	192”	204”	216”	228”
\$2,190.75	\$2,222.00	\$2,253.25	\$2,284.50	\$2,315.75	\$2,347.00	\$2,378.25	\$2,409.50

## Controls



**VRF01-WH**  
RF 1 ch. remote



**VRF15-WH**  
RF 15 ch. remote



**BEXPRO-WH**  
Smart IP Bridge  
for automation

# R3 SERIES

## MANUAL ROMAN SHADE



### PROFILE

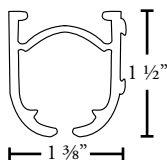

### AVAILABLE COLOR



WH

**R3TR19-WH**  
White Track 19'  
\$7.60/ft.

### PRODUCT INFORMATION

- Elegant Roman shade lift system
- Durable and functional enclosed design
- Integrated velcro hook tape on top
- Hassle-free installation
- Easy adjustment of cord drums
- Max length available in one piece: 228"
- Advanced aluminum extrusion
- Chromated white powder coated
- Metal chain finishes Nickel and Bronze
- 3 control ratios available:
  - a) 1:1 holds up to 10 lbs
  - b) 1:2 holds up to 15 lbs
  - c) 1:4 holds up to 20 lbs
- Bead chain operated
- Cannot be curved nor bent
- Cannot be spliced

### ASSEMBLED PRICING

Includes: track cut to size, cord roll supports, control unit, bead chain, brackets and counterweight. \$126.00 for the first 36 in. Each additional **inch** \$2.75. Freight not included.

First 36"	48"	60"	72"	84"	96"	108"	120"
\$126.00	\$159.00	\$192.00	\$225.00	\$258.00	\$291.00	\$324.00	\$357.00
132"	144"	156"	168"	180"	192"	204"	216"
\$390.00	\$423.00	\$456.00	\$489.00	\$522.00	\$555.00	\$588.00	\$621.00

## COMPONENTS



**R3COR-WH**  
Cord Roll Support with EZ lock (no screws needed)  
\$6.75 ea. 100/box



**R3ROD16-AL**  
Aluminum Rod 16'  
\$2.32/ft.



**ACW19-AL**  
Counterweight 19'  
\$2.15/ft.



Control Unit w/ End Cap  
**R3CON11-WH**  
Ratio 1:1 up to 10 lbs.  
**R3CON12-WH**  
Ratio 1:2 up to 15 lbs.  
**R3CON14-WH**  
Ratio 1:4 up to 20 lbs.  
\$14.63 ea. 100/box



Plastic Endless Chain  
**R3PEC29-WH** \$2.34 ea.  
**R3PEC39-WH** \$2.71 ea.  
**R3PEC49-WH** \$3.35 ea.  
**R3PEC59-WH** \$3.72 ea.  
**R3PEC69-WH** \$3.91 ea.  
**R3PEC79-WH** \$4.04 ea.  
**R3PEC89-WH** \$4.17 ea.  
**R3PEC99-WH** \$4.52 ea.



**R3SWB-WH**  
Swivel Wall Bracket  
\$1.98 ea. 100/bag



**R3SCB-WH**  
Swivel Ceiling Bracket  
\$2.25 ea. 200/bag



**R3KWB-WH**  
Klick Wall Bracket  
\$2.25 ea. 200/bag



**R3KCB-WH**  
Klick Ceiling Bracket  
\$2.25 ea. 200/bag



**PVE13-WH**  
Velcro Profile w/Tape  
\$4.09/ft.



**R3VBR-WH**  
Valance Bracket  
\$2.59 ea. 50/box



**R3VCO-WH**  
Valance Corners  
\$3.75 ea. 500/box



**TVE27-WH**  
Velcro Tape  
\$29.04/roll. 27 yds/roll



**SPN19-WH**  
Fiberglass Spines, 19'  
\$0.46/ft.

## Other Components



**SRI14-WH**  
Plastic Snap Ring  
\$0.10 ea. 500/bag



**RRI13-CL**  
Plastic Ring Cord Guide  
\$0.10 ea. 1000/bag



**SHR73-WH**  
Shroud  
\$284.52/roll. 73 yds/roll



**CTEN07-WH**  
EZ Clip Tension Device  
\$5.25 ea.



**CTEN05-CL**  
Tension Device  
\$7.29 ea.



**R3LEV-CL**  
Shade Leveler  
\$0.49 ea. 1000/bag

For more information visit [www.angbejar.com](http://www.angbejar.com)

# R5 SERIES

## MOTORIZED ROMAN SHADE

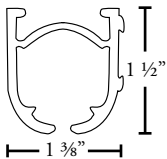

**R3TR19-WH**  
White Track 19'

WH

### PRODUCT INFORMATION

- Elegant Roman shade lift system
- Durable and functional enclosed design
- Integrated velcro hook tape on top
- Hassle-free installation
- Easy adjustment of cord drums
- Max length available in one piece: 228"
- Max weight 10 lbs.
- Advanced aluminum extrusion
- Chromated white powder coated
- Somfy available
- 3 power options available:
  - a) 24v Plug-in motor
  - b) Battery wand motor
  - c) Lithium battery motor
- Cannot be curved nor bent
- Cannot be spliced

### Brackets



**R3SWB-WH**  
Swivel Wall Bracket



**R3SCB-WH**  
Swivel Ceiling Bracket



**R3KWB-WH**  
Klick Wall Bracket



**R3KCB-WH**  
Klick Ceiling Bracket

## ASSEMBLED PRICING FOR BATTERY WAND MOTOR

Includes: track cut to size, cord roll supports, “V” class motor, battery wand\*, brackets, counterweight and 1 channel RF remote. \$720.25 for the first 36 in. Each additional **inch** \$3.00. Freight not included.

First 36"	48"	60"	72"	84"	96"	108"	120"
\$720.25	\$756.25	\$792.25	\$828.25	\$864.25	\$900.25	\$936.25	\$972.25
132"	144"	156"	168"	180"	192"	204"	216"
\$1,008.25	\$1,044.25	\$1,080.25	\$1,116.25	\$1,152.25	\$1,188.25	\$1,224.25	\$1,260.25

## ASSEMBLED PRICING FOR LITHIUM BATTERY MOTOR

Includes: track cut to size, cord roll supports, “V” class motor, lithium battery adaptor, brackets, counterweight and 1 channel RF remote. \$815.50 for the first 36 in. Each additional **inch** \$3.00. Freight not included.

First 36"	48"	60"	72"	84"	96"	108"	120"
\$815.50	\$851.50	\$887.50	\$923.50	\$959.50	\$995.50	\$1,031.50	\$1,067.50
132"	144"	156"	168"	180"	192"	204"	216"
\$1,103.50	\$1,139.50	\$1,175.50	\$1,211.50	\$1,247.50	\$1,283.50	\$1,319.50	\$1,355.50

### Controls



**VRF01-WH**  
RF 1 ch. remote



**VRF15-WH**  
RF 15 ch. remote



**BEXPRO-WH**  
Smart IP Bridge  
for automation

## ASSEMBLED PRICING FOR SOMFY “S-25” CLASS MOTOR

Includes: track cut to size, cord roll supports, somfy “S-25” class motor, lithium battery adaptor, brackets, counterweight and 1 channel RF remote. \$993.50 for the first 36 in. Each additional **inch** \$3.00. Freight not included.

First 36"	48"	60"	72"	84"	96"	108"	120"
\$993.50	\$1,029.50	\$1,065.50	\$1,101.50	\$1,137.50	\$1,173.50	\$1,209.50	\$1,245.50
132"	144"	156"	168"	180"	192"	204"	216"
\$1,281.50	\$1,317.50	\$1,353.50	\$1,389.50	\$1,425.50	\$1,461.50	\$1,497.50	\$1,533.50

### Controls



**RCS01-WH**  
RTS Remote  
Control 1 ch.  
\$238.30 ea.



**RCS05-WH**  
RTS Situo Remote  
Control 5 ch.  
\$299.65 ea.



**BEXPRO-WH**  
Smart IP Bridge  
for automation

For more information visit [www.angbejar.com](http://www.angbejar.com)

# R6 SERIES

## 2 1/4" MANUAL ROMAN SHADE



### PROFILE

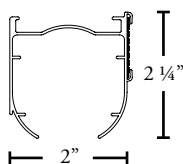

### AVAILABLE COLOR



WH

**R6TR19-WH**  
White Track 19'  
\$11.50/ft.

### PRODUCT INFORMATION

- Elegant Roman shade lift system
- Durable and functional enclosed design
- Integrated velcro hook tape on top
- Hassle-free installation
- Easy adjustment of cord drums
- Max length available in one piece: 228"
- Advanced aluminum extrusion
- Chromated white powder coated
- 1:4 holds up to 24 lbs
- Bead chain operated
- Cannot be curved nor bent
- Cannot be spliced

### ASSEMBLED PRICING

Includes: track cut to size, cord roll supports, control unit, bead chain, brackets and counterweight. \$159.50 for the first 4 ft. Each additional **inch** \$3.35. Freight not included.

First 48"	60"	72"	84"	96"	108"	120"	132"
\$159.50	\$199.70	\$239.90	\$280.10	\$320.30	\$360.50	\$400.70	440.90
144"	156"	168"	180"	192"	204"	216"	228"
\$481.10	\$521.30	\$561.50	\$601.70	\$641.90	\$682.10	\$722.30	\$762.50



## COMPONENTS



**R6COR-WH**  
Cord Roll Support with EZ lock (no screws needed)  
\$7.04 ea. 100/box



**R6ROD16-AL**  
Aluminum Rod 16'  
\$2.30/ft.



**ACW19-AL**  
Counterweight 19'  
\$2.03/ft.



Control Unit w/ End Cap  
**R6CON14-WH**  
Ratio 1:4 up to 20 lbs.  
\$20.13 ea. 100/box



Plastic Endless Chain  
**R6PEC29-WH** \$2.29 ea.  
**R6PEC39-WH** \$2.66 ea.  
**R6PEC49-WH** \$3.28 ea.  
**R6PEC59-WH** \$3.65 ea.  
**R6PEC69-WH** \$3.84 ea.  
**R6PEC79-WH** \$3.96 ea.  
**R6PEC89-WH** \$4.09 ea.  
**R6PEC99-WH** \$4.44 ea.



**R6KCB-WH**  
Klick Ceiling Bracket  
\$3.21 ea. 100/box



**R6KWB-WH**  
Klick Wall Bracket  
\$8.37 ea. 100/box



**TVE27-WH**  
Velcro Tape  
\$29.04/roll. 27 yds/roll



**SPN19-WH**  
Fiberglass Spines, 19'  
\$0.46/ft.



**R6LEV-CL**  
Shade Leveler  
\$0.48 ea. 1000/bag



**SRI14-WH**  
Plastic Snap Ring  
\$0.09 ea. 500/bag



**RRI13-CL**  
Plastic Ring Cord Guide  
\$0.09 ea. 1000/bag



**SHR73-WH**  
Shroud  
\$301.74/roll 73 yds/roll



**CTEN07-WH**  
EZ Clip Tension Device  
\$5.25 ea.



**CTEN05-CL**  
Tension Device  
\$7.29 ea.

For more information visit [www.angbejar.com](http://www.angbejar.com)

# R7 SERIES

## MOTORIZED ROMAN SHADE



### PROFILE

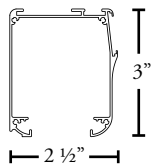

### AVAILABLE COLOR



**R7TR19-WH**  
White Track 19'  
\$13.17/ft.

### PRODUCT INFORMATION

- Elegant motorized roman shade lift system
- Integrated velcro hook tape on top
- Hassle-free installation
- Easy adjustment of cord drums
- Max length available in one piece: 228"
- Advanced aluminum extrusion
- Chromated white powder coated
- Max fabric weight 45 lbs.
- Max height 216"
- AC Tubular Motor can be hard wired
- AC Tubular Motor with built-in RF Receiver available
- Radio frequency control available
- Cannot be curved nor bent
- Cannot be spliced

### ASSEMBLED PRICING

Includes: track cut to size, cord roll supports, motor, RF remote, brackets and counterweight. \$1,258.75 for the first 3 ft. Each additional foot \$89.75. Freight not included.

First 36"	48"	60"	72"	84"	96"	108"	120"
\$1,258.75	\$1,348.50	\$1,438.25	\$1,528.00	\$1,617.75	\$1,707.50	\$1,797.25	\$1,887.00
132"	144"	156"	168"	180"	192"	204"	216"
\$1,976.75	\$2,066.50	\$2,156.25	\$2,246.00	\$2,335.75	\$2,425.50	\$2,515.25	\$2,605.00

## COMPONENTS



**R7MRF01**  
Tubular Motor with built-in Receiver  
\$638.44 ea. 1/box



**R7TUB-WH**  
8-Angle Tube, 19'  
\$5.53/ft.



**R7END-WH**  
Left & Right End Caps  
\$5.39 set 25 sets/box



**R7BRA-WH**  
Wall/Ceiling Bracket  
\$15.81 ea. 25/box



**R7CST-WH**  
Center Support  
\$15.71 ea. 25/box



**R7COR-WH**  
Cord Roll House & Drum  
\$53.79 ea. 25/box



**R3LEV-CL**  
Shade Leveler  
\$0.49 ea. 1000/bag



**R7TST-WH**  
Tube Support  
\$27.16 ea. 25/box



**R7VEL-WH**  
Velcro 7/8" x 4'  
\$14.40/ft. 25/box



**SPN19-WH**  
Fiberglass Rod, 19'  
\$0.46/ft.



**ACW19-AL**  
Counterweight, 19'  
\$2.15/ft. 20/bundle



**RFW02-WH**  
RF Wireless Wall Switch with 2 Channels  
\$181.42 ea.



**RFC15-WH**  
RF Multi Remote 15 ch.  
\$368.59 ea.



**SHR73-WH**  
Shroud  
\$260.82/roll, 73 yds/roll



**R7MDR03**  
Tubular Motor Dry Contact  
\$332.04 ea.

For more information visit [www.angbejar.com](http://www.angbejar.com)

# PS SERIES

## PANEL TRACK



### PROFILE

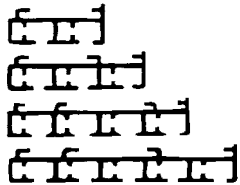

### AVAILABLE COLORS



- PS2TR19-WH 2-Channel White Track 19' \$6.58 ft.**
- PS3TR19-WH 3-Channel White Track 19' \$8.28 ft.**
- PS4TR19-WH 4-Channel White Track 19' \$11.09 ft.**
- PS5TR19-WH 5-Channel White Track 19' \$13.26 ft.**

### PRODUCT INFORMATION

- Stylish panel track system (vertical sliding panels)
- Integrated velcro hook tape on top
- Hassle-free installation
- Max length available in one piece: 228"
- Advanced aluminum extrusion
- Chromated white powder coated
- Max fabric weight 10 lbs/panel

- Max panel width 156"
- Cannot be curved nor bent

### APPLICATIONS

- Center draw
- One-way draw
- Off-center draw

### ASSEMBLED PRICING

Includes: track cut to size, velcro profile, carriers, angles, end caps, 36" fiberglass batons, brackets and counterweight. Freight not included.

**2-Channel** first 4 ft \$187.00. Each additional foot \$29.00

**3-Channel** first 4 ft \$212.00. Each additional foot \$34.75

**4-Channel** first 4 ft \$249.00. Each additional foot \$41.50

**5-Channel** first 4 ft \$291.00. Each additional foot \$47.50

Chart below shows assembled price for PS 3-Channel System.

First 48"	60"	72"	84"	96"	108"	120"	132"
\$212.00	\$246.75	\$281.50	\$316.25	\$351.00	\$385.75	\$420.50	\$455.25
144"	156"	168"	180"	192"	204"	216"	228"
\$490.00	\$524.75	\$559.50	\$594.25	\$629.00	\$663.75	\$698.50	\$733.25

## COMPONENTS



**PSE310-WH**  
2-Channel End Cap  
Requires End Cap Cover  
\$0.92 ea.



**PSE311-WH**  
3, 4 & 5-Channel End Cap  
Requires End Cap Cover  
\$1.47 ea.



**PSE312-WH**  
2-Channel Cover for End  
Cap and Pulley  
\$0.53 ea.



**PSE309-WH**  
3, 4 & 5-Channel Cover for  
End Cap and Pulley  
\$0.94 ea.



**PSC007-WH**  
Wheeled Carrier  
\$1.22 ea.



**PSS202-WH**  
Catcher, T-Angle  
\$0.53 ea.



**PSS203-WH**  
Stopper, A-Angle  
\$0.53 ea.



**PSS204-WH**  
L End Stop  
\$0.53 ea.



**PSS209-WH**  
Reverse L Stop  
\$0.53 ea.



**PSB510-WH**  
Baton Adaptor  
\$1.12 ea.



**PSB003-SL**  
Swivel Ceiling Bracket for  
2, 3 & 4 Channel Tracks  
\$0.94 ea.



**PSB002-WH**  
Klick On Ceiling Bracket  
2-4 Channel \$1.19ea.



**PSB004-WH**  
Wall Bracket  
2, 3 & 4 Channel \$2.86 ea.



**PSV90-WH**  
Valance Bracket  
\$2.61 ea. 50/box



**PSV91-WH**  
Valance Corners  
\$3.75 ea. 500/box

**PSB005-WH**  
5 Channel \$1.79 ea.

**PSB006-WH**  
5 Channel \$3.50 ea.



**PVE13-WH**  
Profile w/Hook Tape  
\$4.09/ft. 20/bundle



**ACW19-AL**  
Counterweight Bar, 19'  
\$2.15/ft. 20/bundle



**PSS308-SL**  
Stationary Set Screw  
\$0.46 ea. 500/bag



**TVE27-WH**  
Velcro Tape  
\$29.04 roll. 27 yds/roll

For more information visit [www.angbejar.com](http://www.angbejar.com)



# Decorative Rails

*Embracing fashion and function.* AngBéjar offers over 20 unique stains, lacquers, and metal finishes. From traditional to modern, craftsman to industrial, each finish comes from the highest European quality and local artisanship.

Our decorative brackets design works perfect for large windows and long spans. The brackets grab the rail from the top, which allows gliders unfettered access across the entire bottom rail of the track.

We offer custom cuts and assembly to your specifications. Whether you need center draw, one-way draw, pinch pleat, or rippled fold, AngBéjar can do it. Some collections can also be custom bent or curved.

- Shop our best-selling H-Rail *Urban Collection*. Seven different finishes, plenty of finials to choose from and our unique double brackets for pinch pleat and ripplefold\* projections.
- Best Rectangle Rail - The *Avalon Collection* offers 4 gorgeous finishes for a stylish look that can be baton and cord drawn.
- Our motorized *Berlin Collection* has even more motorization options and now with the BEXPRO can work with any smart system.

AngBéjar

# URBAN COLLECTION

## 1 1/8" DECORATIVE RAIL



### AVAILABLE FINISHES

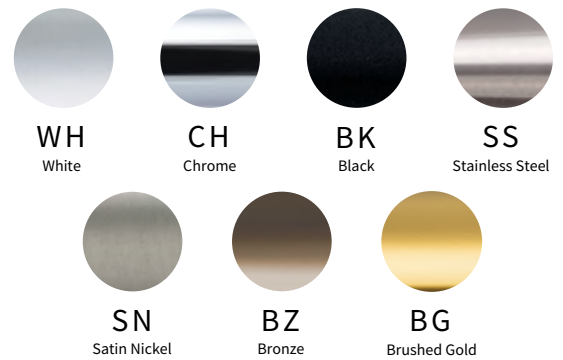

### PRODUCT INFORMATION

- Material: Aluminum
- Components materials: Aluminum/Steel
- Collection style: Classic/Modern
- Max length available in one piece: 244"
- Brackets: Recommended every 3-5 feet depending on fabric weight
- Can be curved and bent (see p.132)
- Splice not recommended for one-way draw

### ASSEMBLED PRICING

- Single set pricing includes: rail cut to size, end cap finials, single brackets, carriers, masters and 36" fiberglass baton. \$328.00 for the first 4 ft. Each additional foot \$38.00. Freight not included.
- Double set first 4 ft. \$565.00 and each additional foot \$65.00. Freight not included.

### STYLES

- Pinch pleat
- Ripplefold\*
- Cubicle
- FlexWave

### APPLICATIONS

- Center draw
- One-way draw
- Off-center draw

First 48"	60"	72"	84"	96"	108"	120"	132"
\$328.00	\$366.00	\$404.00	\$442.00	\$480.00	\$518.00	\$556.00	\$594.00
144"	156"	168"	180"	192"	204"	216"	228"
\$632.00	\$670.00	\$708.00	\$746.00	\$784.00	\$822.00	\$860.00	\$898.00



# COMPONENTS

## Finials



**URB828-XX**  
Urban Rail 20'  
\$13.72/ft.



Profile



**URB121-XX**  
End Cap Finial  
\$17.27 ea.

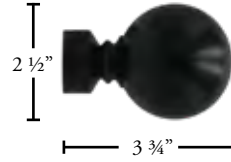

**URB122-XX**  
Lazio Ball Finial  
\$42.75 ea.

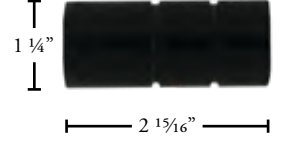

**URB123-XX**  
Westin Finial  
\$42.75 ea.

## Brackets

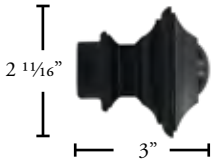

**URB124-XX**  
Zeus Finial  
\$47.04 ea.



**URB125-XX**  
Aspen Finial  
\$47.04 ea.

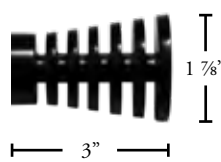

**URB126-XX**  
Naxos Finial  
\$49.33 ea.

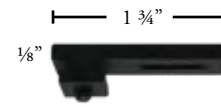

**URB225-XX**  
Flush Ceiling Bracket  
\$17.75 ea.



**URB226-XX**  
Inside Mount Bracket  
\$27.73 ea.

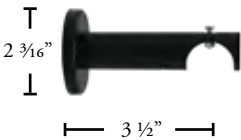

**URB221-XX**  
Single Bracket  
\$33.23 ea.

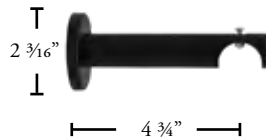

**URB222-XX**  
Extended Single Bracket  
\$37.86 ea.

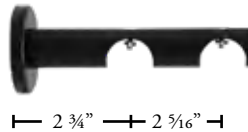

**URB224-XX**  
Pinch Pleat Double Bracket  
\$40.72 ea.

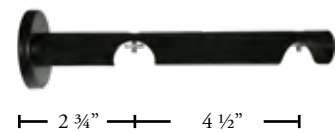

**URB223-XX**  
Ripplefold Double Bracket  
\$45.84 ea.

## Other Components



**URB227-XX**  
Ceiling Bracket  
\$29.65 ea.



**RCARS60-WH** 60% Fullness  
**RCARS80-WH** 80% " "  
**RCARS100-WH** 100% " "  
**RCARS120-WH** 120% " "  
2 piece Connected Snap  
\$1.02 ea. 500/roll



**RCARB60-WH** 60% Fullness  
**RCARB80-WH** 80% " "  
**RCARB100-WH** 100% " "  
**RCARB120-WH** 120% " "  
B/B Connected Snap  
\$1.65 ea.



**BCAR02-WH**  
Slim Ball Bearing  
\$0.58 ea. 1000/box



**END307**  
End Lock  
\$0.81 ea. 100/box



**URB410-XX**  
Swivel Elbow  
\$54.15 ea.



**URB602-SL**  
Small Mounting Block  
\$1.11 ea.



**URB601-SB**  
Rail Splice Connector  
\$13.55 ea.

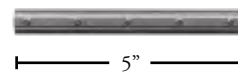

**URB605-SL**  
Extra Long HD Splice  
\$20.30 ea.



For batons see p.126

# AMSTERDAM COLLECTION

## 1 1/8" DECORATIVE RAIL



### AVAILABLE FINISHES

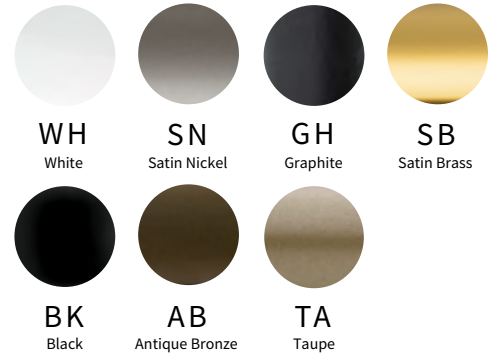

### PRODUCT INFORMATION

- Material: Aluminum
- Components materials: Aluminum/Steel
- Collection style: Classic/Modern
- Max length available in one piece: 228"
- Brackets: Recommended every 3-5 feet depending on fabric weight
- Can be curved and bent (see p.132)
- Splice not recommended for one-way draw

### STYLES

- Pinch pleat
- Ripplefold\*
- Cubicle
- FlexWave

### APPLICATIONS

- Center draw
- One-way draw
- Off-center draw

### ASSEMBLED PRICING

Single set pricing includes: rail cut to size, end cap finials, single brackets, carriers, masters and 36" fiberglass baton. \$547.75 for the first 4 ft. Each additional foot \$66.25. Freight not included.

First 48"	60"	72"	84"	96"	108"	120"	132"
\$547.75	\$614.00	\$680.25	\$746.50	\$812.75	\$879.00	\$945.25	\$1,011.50
144"	156"	168"	180"	192"	204"	216"	228"
\$1,077.75	\$1,144.00	\$1,210.25	\$1,276.50	\$1,342.75	\$1,409.00	\$1,475.25	\$1,541.50

# COMPONENTS

## Finials



**AMS828-XX**  
Amsterdam Rail 19'  
\$16.74/ft.



Profile

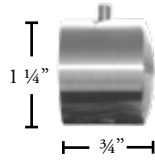

**AMS121-XX**  
End Cap Finial  
\$41.94 ea.

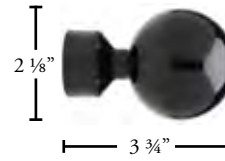

**AMS124-XX**  
Ball Finial  
\$87.90 ea.

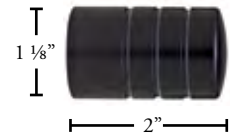

**AMS125-XX**  
Notched Finial  
\$48.41 ea.

## Brackets



**AMS221-XX**  
Single Bracket 3"  
\$60.59 ea.

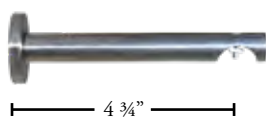

**AMS222-XX**  
Extended Single Bracket  
\$79.79 ea.

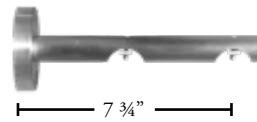

**AMS223-XX**  
Double Bracket  
\$128.24 ea.

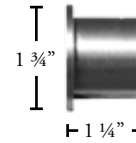

**AMS226-XX**  
Inside Mount Bracket  
\$95.83 ea.

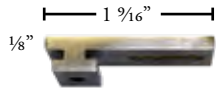

**AMS225-XX**  
Flush Ceiling Bracket  
\$22.11 ea.

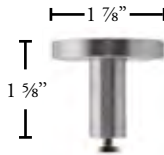

**AMS227-XX**  
Ceiling Bracket  
\$60.22 ea.



**AMS502-XX**  
Bracket Extension  
\$78.74 ea.

## Masters



**RMAS301-WH** Over R  
**RMAS302-WH** Under L  
Ripplefold Master w/  
Snaps and Adaptor  
\$7.60 ea. 100/box



**PMAS101-WH** Over R  
**PMAS102-WH** Under L  
Pinch Pleat Master  
Multifunctional  
\$6.01 ea. 100/box



**BMAS209-WH** Left  
**BMAS210-WH** Right  
Butt w/3 Snaps  
\$14.97 ea. 15/box



**BMAS401-WH** Right  
**BMAS402-WH** Left  
Wheeled Butt Master  
\$22.75 ea. 15/box



**RCARS60-WH** 60% Fullness  
**RCARS80-WH** 80% "  
**RCARS100-WH** 100% "  
**RCARS120-WH** 120% "  
2 piece Connected Snap  
\$1.02 ea. 500/roll



**RCARB60-WH** 60% Fullness  
**RCARB80-WH** 80% "  
**RCARB100-WH** 100% "  
**RCARB120-WH** 120% "  
B/B Connected Snap  
\$1.65 ea.



**BCAR02-WH**  
Slim Ball Bearing  
\$0.58 ea. 1000/box



**END307**  
End Lock  
\$0.81 ea. 100/box

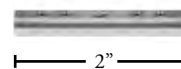

**AMS601-SB**  
Rail Connector  
\$20.73 ea.



For batons see p.126

## Other Components

For more information visit [www.angbejar.com](http://www.angbejar.com)

# BARCELONA COLLECTION

## 1 1/8" DECORATIVE FAUX WOOD RAIL



### AVAILABLE FINISHES

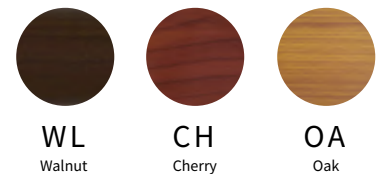

WL  
Walnut

CH  
Cherry

OA  
Oak

### PRODUCT INFORMATION

- Material: Aluminum
- Components materials: Aluminum/Steel
- Collection style: Classic/Modern
- Max length available in one piece: 240"
- Brackets: Recommended every 3-5 feet depending on fabric weight
- Can be curved and bent (see p.132)
- Splice not recommended for one-way draw

### STYLES

- Pinch pleat
- Ripplefold\*
- Cubicle
- FlexWave

### APPLICATIONS

- Center draw
- One-way draw
- Off-center draw

### ASSEMBLED PRICING

Single set pricing includes: rail cut to size, end cap finials, single brackets, carriers, masters and 36" fiberglass baton. \$655.00 for the first 4 ft. Each additional foot \$94.75. Freight not included.

First 48"	60"	72"	84"	96"	108"	120"	132"
\$655.00	\$749.75	\$844.50	\$939.25	\$1,034.00	\$1,128.75	\$1,223.50	\$1,318.25
144"	156"	168"	180"	192"	204"	216"	228"
\$1,413.00	\$1,507.75	\$1,602.50	\$1,697.25	\$1,792.00	\$1,886.75	\$1,981.50	\$2,076.25

# COMPONENTS



**BAR828-XX**  
Barcelona Rail 19'  
\$30.81/ft.

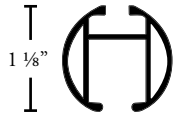

Profile

## Finials

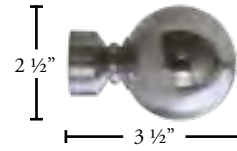

**BAR124-XX**  
Sphere Finial  
\$98.77 ea.

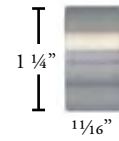

**BAR123-XX**  
End Cap Finial  
\$30.37 ea.

## Brackets

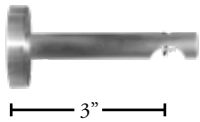

**BAR221-XX**  
Single Bracket 3"  
\$60.59 ea.

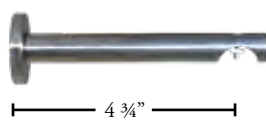

**BAR222-XX**  
Extended Single Bracket  
\$79.79 ea.

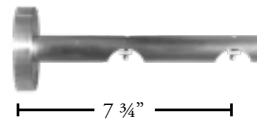

**BAR223-XX**  
Double Bracket  
\$128.24 ea.

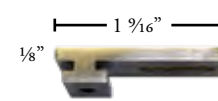

**BAR225-XX**  
Flush Ceiling Bracket  
\$22.11 ea.

Compatible finials and brackets from Urban (p.38), Amsterdam (p.40) & Munich Collections (p.44).

## Masters



**RMAS301-WH** Over R  
**RMAS302-WH** Under L  
Ripplefold Master w/  
Snaps and Adaptor  
\$7.60 ea. 100/box



**PMAS101-WH** Over R  
**PMAS102-WH** Under L  
Pinch Pleat Master  
Multifunctional  
\$6.01 ea. 100/box



**BMAS209-WH** Left  
**BMAS210-WH** Right  
Butt w/3 Snaps  
\$14.97 ea. 15/box



**BMAS401-WH** Right  
**BMAS402-WH** Left  
Wheeled Butt Master  
\$22.75 ea. 15/box



**RCARS60-WH** 60% Fullness  
**RCARS80-WH** 80% "  
**RCARS100-WH** 100% "  
**RCARS120-WH** 120% "  
2 piece Connected Snap  
\$1.02 ea. 500/roll

## Other Components



**RCARB60-WH** 60% Fullness  
**RCARB80-WH** 80% "  
**RCARB100-WH** 100% "  
**RCARB120-WH** 120% "  
B/B Connected Snap  
\$1.65 ea.



**BCAR02-WH**  
Slim Ball Bearing  
\$0.58 ea. 1000/box



**END307**  
End Lock  
\$0.81 ea. 100/box



**BAR601-SB**  
Rail Splice Connector  
\$13.55 ea.



**URB605-SL**  
Extra Long HD Splice  
\$20.30 ea.

For more information visit [www.angbejar.com](http://www.angbejar.com)

# MUNICH COLLECTION

## 1 1/8" DECORATIVE RAIL



### AVAILABLE FINISHES



### PRODUCT INFORMATION

- Material: Aluminum
- Components materials: Brass/Steel
- Collection style: Classic/Modern/Contemporary
- Max length available in one piece: 228"
- Brackets: Recommended every 3-5 feet depending on fabric weight
- Can be curved and bent (PC finish excluded). See p.132
- Splice not recommended for one-way draw

### STYLES

- Pinch pleat
- Ripplefold\*
- Cubicle
- FlexWave

### APPLICATIONS

- Center draw
- One-way draw
- Off-center draw

### ASSEMBLED PRICING

Single set pricing includes: rail cut to size, end cap finials, single brackets, carriers, masters and 36" fiberglass baton. \$679.50 for the first 4 ft. Each additional foot \$101.50. Freight not included.

First 48"	60"	72"	84"	96"	108"	120"	132"
\$679.50	\$781.00	\$882.50	\$984.00	\$1,085.50	\$1,187.00	\$1,288.50	\$1,390.00
144"	156"	168"	180"	192"	204"	216"	228"
\$1,491.50	\$1,593.00	\$1,694.50	\$1,796.00	\$1,897.50	\$1,999.00	\$2,100.50	\$2,202.00

# COMPONENTS



**MUN828-XX**  
Munich Rail 19'  
\$29.90/ft. -PC, -SB, -BZ,  
-BK, -BN, -SG  
\$35.88/ft. -BE, -OA, -WL

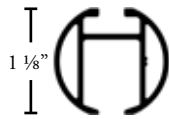

Profile

## Finials

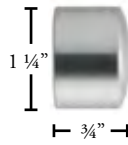

**MUN121-XX**  
End Cap Finial  
\$49.00 ea.

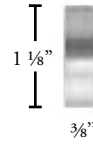

**ALE137-XX**  
Alea Finial  
\$69.54 ea.

More available  
finials for this  
collection in p.47



## Brackets

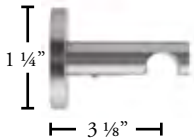

**MUN221-XX**  
Single Bracket  
\$154.00 ea.

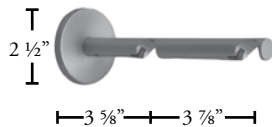

**MUN223-XX**  
Double Bracket  
\$185.50 ea.

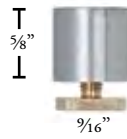

**MUN244-XX**  
Ceiling Bracket  
\$59.50 ea.

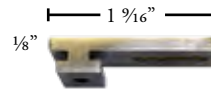

**MUN225-XX**  
Flush Ceiling Bracket  
\$22.11 ea.

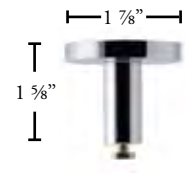

**MUN227-XX**  
Ceiling Bracket 2"  
\$111.99 ea.

## Other Components



**MUN228-XX**  
French Return Bracket  
\$178.53 ea.



**END306-WH**  
End Stop  
\$0.77 ea.

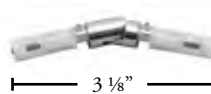

**MUN410-XX**  
Swivel Elbow  
\$186.29 ea.

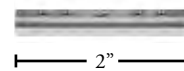

**MUN601-SB**  
Rail Connector  
\$20.73 ea.



For batons see p.126

† Rail Only

For more information visit [www.angbejar.com](http://www.angbejar.com)

# LYON COLLECTION

## 1 1/8" DECORATIVE CORDED RAIL

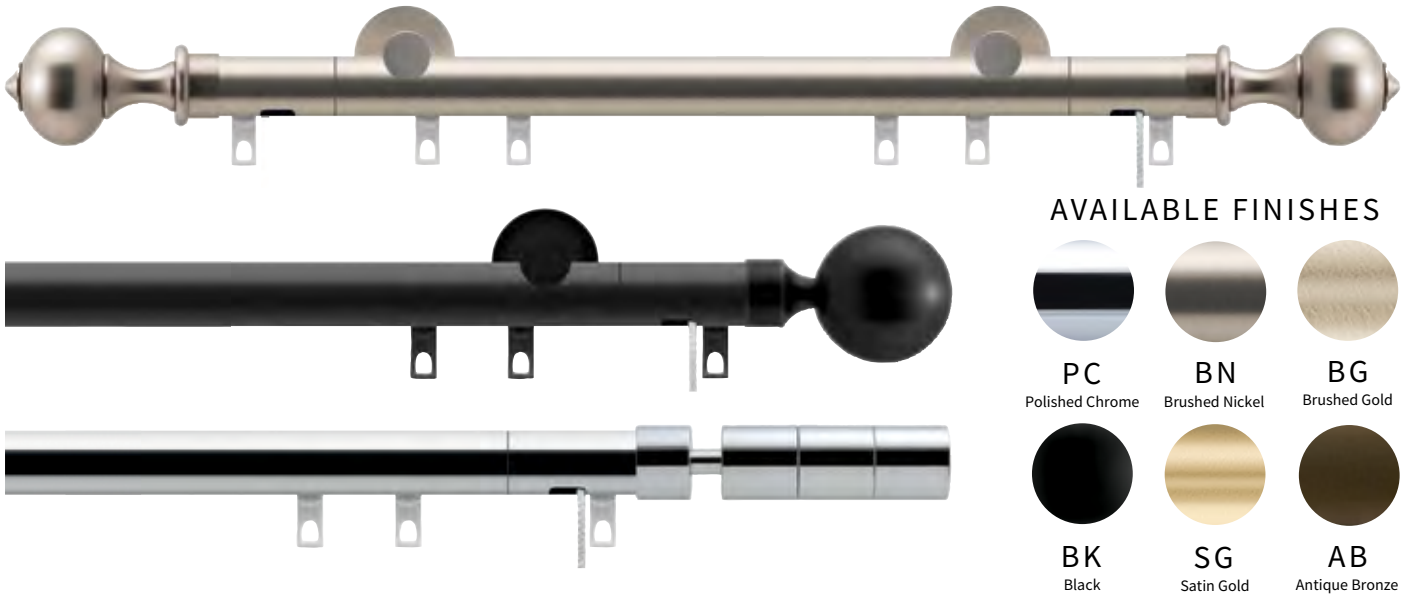

### PRODUCT INFORMATION

- Material: Aluminum
- Components material: Brass
- Collection style: Modern/Contemporary
- Max length available in one piece: 233"
- Brackets: Recommended every 3-5 feet depending on fabric weight
- Recommended for light weight drapery only
- Can be curved and bent (PC finish excluded). See p. 132
- Splice not recommended for one-way draw

### STYLES

- Pinch pleat
- Ripplefold\*
- FlexWave

### APPLICATIONS

- Center draw
- One-way draw
- Off-center draw

### ASSEMBLED PRICING

Single set pricing includes: rail cut to size, end cap pulleys, carriers, masters, cord and single brackets. \$901.50 for the first 4 ft. Each additional foot \$111.75. Freight not included.

First 48"	60"	72"	84"	96"	108"	120"	132"
\$901.50	\$1,013.25	\$1,125.00	\$1,236.75	\$1,348.50	\$1,460.25	\$1,572.00	\$1,683.75
144"	156"	168"	180"	192"	204"	216"	228"
\$1,795.50	\$1,907.25	\$2,019.00	\$2,130.75	\$2,242.50	\$2,354.25	\$2,466.00	\$2,577.75



# COMPONENTS



**LYO828-XX**  
Lyon Rail 19'7"  
\$50.41/ft.



Profile



**END121-XX**  
Decorative Cord Pulley  
\$94.51 ea.

Finials also compatible with  
Munich Collection (p.44) and  
Berlin Collection (p.48)

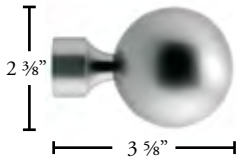

**ALA124-XX**  
Allassio Finial  
\$279.97 ea.



**NAP126-XX**  
Napoli Finial\*  
\$347.73 ea.

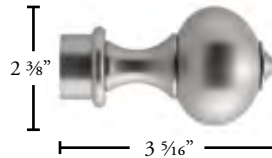

**VER127-XX**  
Verona Finial\*  
\$379.32 ea.

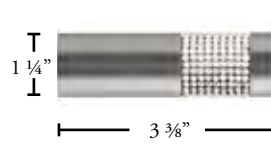

**GAL130-XX**  
Galaxy Finial  
\$393.70 ea.

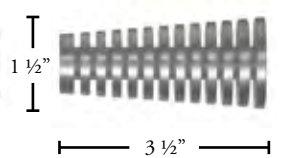

**ISC125-XX**  
Iscia Finial\*  
\$240.28 ea.

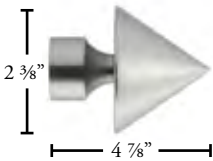

**RIV122-XX**  
Riva Finial\*  
\$230.98 ea.

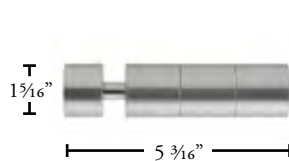

**PES123-XX**  
Pescara Finial  
\$276.50 ea.

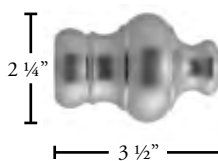

**ALS128-XX**  
Allessandria Finial\*  
\$130.86 ea.



**ROM129-XX**  
Roma Finial\*  
\$490.57 ea.

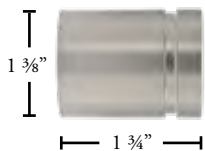

**TER133-XX**  
Terra Finial\*  
\$118.50 ea.



**TAH134-XX**  
Tahoe Finial\*  
\$151.39 ea.

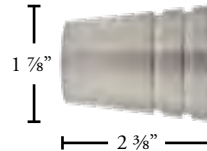

**ZEN135-XX**  
Zena Finial\*  
\$147.42 ea.

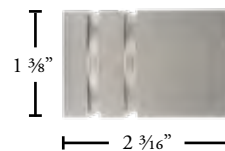

**EDI136-XX**  
Edil Finial\*  
\$154.51 ea.



**ARD131-XX**  
Ardea Finial\*  
\$467.70 ea.

**ASO132-XX**  
Socket for Ardea Finial  
\$94.04 ea.

## Brackets

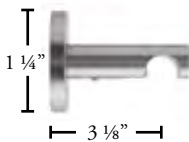

**LYO221-XX**  
Single Bracket  
\$154.00 ea.

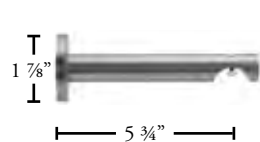

**LYO222-XX**  
Extended Single Bracket  
\$163.56 ea.

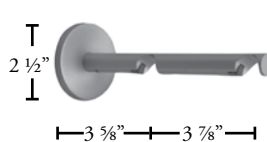

**LYO223-XX**  
Double Bracket  
\$185.50 ea.



**LYO227-XX**  
Ceiling Bracket  
\$111.99 ea.

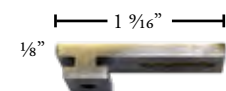

**LYO225-XX**  
Flush Ceiling Bracket  
\$22.11 ea.

\* Not available in Brushed Gold.

For more information visit [www.angbejar.com](http://www.angbejar.com)

# BERLIN COLLECTION

1 1/8" MOTORIZED DECORATIVE METAL

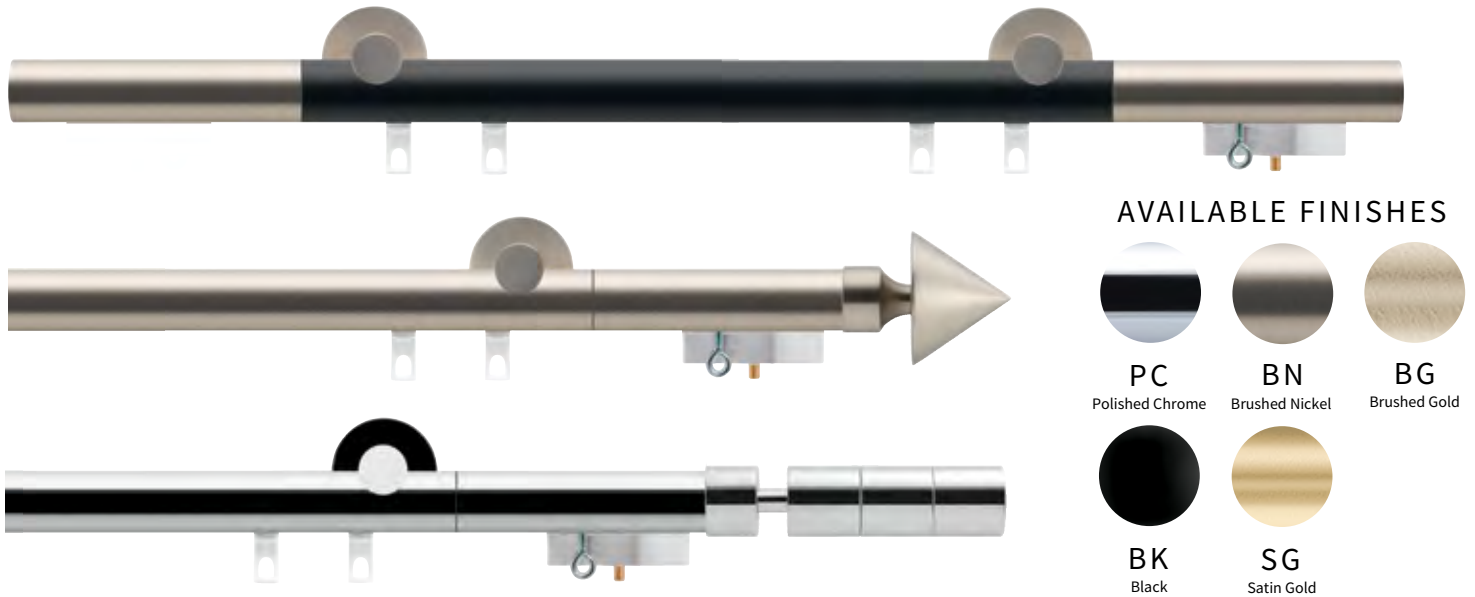

## PRODUCT INFORMATION

- Material: Aluminum
- Collection style: Modern/Contemporary
- Max length available in one piece: 240"
- Brackets: Recommended every 3-5 feet depending on fabric weight
- Can be curved and bent (PC finish excluded). See p. 132
- Splice not recommended for one-way draw
- Uses same motor as M6 Series. See p.24
- Somfy compatible.

## STYLES

- Pinch pleat
- Ripplefold\*
- FlexWave

## APPLICATIONS

- Center draw
- One-way draw
- Off-center draw



Profile

**BER828-XX**  
Berlin Rail 19'7"  
\$49.18/ft.

Available finials for this collection in p.47

## ASSEMBLED PRICING

Includes: rail cut to size and assembled, mounting brackets, "S" class motor, RF remote and power supply. \$2,937.25 for the first 4 ft. Each additional foot \$126.50. Freight not included. Add \$225.00 for HD Motor "M" class. Other components at an additional cost.

First 48"	60"	72"	84"	96"	108"	120"	132"
\$2,937.25	\$3,063.75	\$3,190.25	\$3,316.75	\$3,443.25	\$3,569.75	\$3,696.25	\$3,822.75
144"	156"	168"	180"	192"	204"	216"	228"
\$3,949.25	\$4,075.75	\$4,202.25	\$4,328.75	\$4,455.25	\$4,581.75	\$4,708.25	\$4,834.75



**BER501-XX**  
Left Motor Pulley  
**BER502-XX**  
Right Motor Pulley  
\$566.68 ea.



**BER511-XX**  
Left Return Pulley  
**BER512-XX**  
Right Return Pulley  
\$257.59 ea.



**M6S939-WH**  
Motor "S" class with RF  
Built-in Receiver  
\$920.27 ea.



**RFC15-WH**  
RF Multi Remote 15 ch.  
\$368.59 ea.



**RFW02-WH**  
RF Wireless Wall Switch  
with 2 Channels  
\$181.42 ea.

## ASSEMBLED PRICING SOMFY

Includes: rail cut to size and assembled, mounting brackets, Somfy Irisimo Wire-free motor, RF remote and power supply. \$3,844.50 for the first 4 ft. Each additional foot \$126.50. Freight not included.

Other components at an additional cost.

First 48"	60"	72"	84"	96"	108"	120"	132"
\$3,844.50	\$3,971.00	\$4,097.50	\$4,224.00	\$4,350.50	\$4,477.00	\$4,603.50	\$4,730.00
144"	156"	168"	180"	192"	204"	216"	228"
\$4,856.50	\$4,983.00	\$5,109.50	\$5,236.00	\$5,362.50	\$5,489.00	\$5,615.50	\$5,742.00



**BER505-XX**  
Left Motor Pulley  
**BER506-XX**  
Right Motor Pulley  
\$633.91 ea.



**BER511-XX**  
Right Return Pulley  
**BER512-XX**  
Left Return Pulley  
\$262.50 ea.



**SOM149-WH**  
Somfy Irisimo 45  
Wire-free Motor  
\$1,716.76 ea.



**RCS04-WH**  
RTS Multi Remote 4 ch.  
\$253.45 ea.



**BEXPRO-WH**  
Smart IP Bridge  
for automation

## Brackets

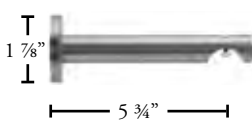

**BER222-XX**  
Single Bracket  
\$160.50 ea.

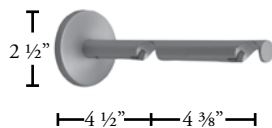

**BER223-XX**  
Double Bracket  
\$182.03 ea.

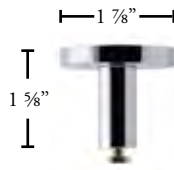

**BER227-XX**  
Ceiling Bracket  
\$109.90 ea.

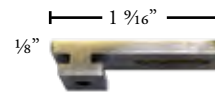

**BER225-XX**  
Flush Ceiling Bracket  
\$21.70 ea.

For more information visit [www.angbejar.com](http://www.angbejar.com)

# SEINE COLLECTION

## 1 1/8" DECORATIVE MOTORIZED RAIL



### AVAILABLE FINISHES

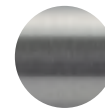

SL  
Silver



GH  
Graphite



AB  
Antique Bronze

### PRODUCT INFORMATION

- Material: Aluminum/Steel
- Components material: Aluminum/Steel
- Collection style: Modern/Contemporary
- Max length available in one piece: 233"
- Brackets: Recommended every 3-5 feet depending on fabric weight
- Can be curved and bent. See p. 132
- Splice not recommended for one-way draw

### STYLES

- Pinch pleat
- Ripplefold\*
- FlexWave

### APPLICATIONS

- Center draw
- One-way draw
- Off-center draw

### ASSEMBLED PRICING "S" MOTOR

Includes: rail cut to size and assembled, mounting brackets, "S" class motor, RF remote and power supply. \$2,698.00 for the first 4 ft. Each additional foot \$81.25. Freight not included. Other components at an additional cost.

First 48"	60"	72"	84"	96"	108"	120"	132"
\$2,698.00	\$2,779.25	\$2,860.50	\$2,941.75	\$3,023.00	\$3,104.25	\$3,185.50	\$3,266.75
144"	156"	168"	180"	192"	204"	216"	228"
\$3,348.00	\$3,429.25	\$3,510.50	\$3,591.75	\$3,673.00	\$3,754.25	\$3,835.50	\$3,916.75

## COMPONENTS

### Finials



**SEI828-XX**  
Seine Rail 19' 7"  
\$47.71/ft.

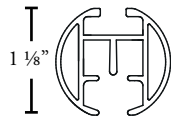

Profile

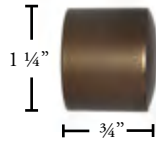

**SEI121-XX**  
End Cap Finial  
\$41.15 ea.

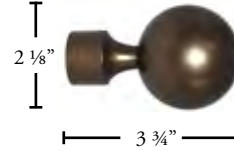

**SEI124-XX**  
Ball Finial  
\$86.25 ea.

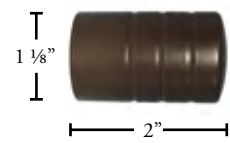

**SEI125-XX**  
Notched Finial  
\$47.51 ea.

### Brackets

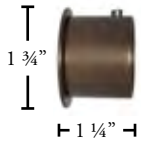

**SEI226-XX**  
Inside Mount Bracket  
\$94.04 ea.

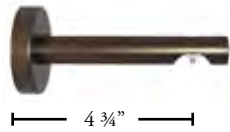

**SEI222-XX**  
Extended Single Bracket  
\$78.29 ea.

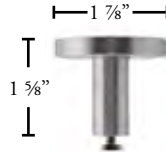

**SEI227-XX**  
Ceiling Bracket  
\$ ea.

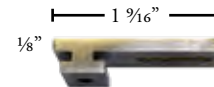

**SEI225-XX**  
Flush Ceiling Bracket  
\$21.70 ea.



**SEI501-XX**  
Left Motor Pulley  
**SEI502-XX**  
Right Motor Pulley  
\$393.55 ea.



**SEI511-XX**  
Left Return Pulley  
**SEI512-XX**  
Right Return Pulley  
\$169.88 ea.



**BEXPRO-WH**  
Smart IP Bridge  
for automation

### ASSEMBLED PRICING "M" MOTOR

Includes: rail cut to size and assembled, mounting brackets, "M" class motor, RF remote and power supply. \$2,781.00 for the first 4 ft. Each additional foot \$81.25. Freight not included.

Other components at an additional cost.

First 48"	60"	72"	84"	96"	108"	120"	132"
\$2,781.00	\$2,862.25	\$2,943.50	\$3,024.75	\$3,106.00	\$3,187.25	\$3,268.50	\$3,349.75
144"	156"	168"	180"	192"	204"	216"	228"
\$3,431.00	\$3,512.25	\$3,593.50	\$3,674.75	\$3,756.00	\$3,837.25	\$3,918.50	\$3,999.75

### ASSEMBLED PRICING "I" MOTOR

Includes: rail cut to size and assembled, mounting brackets, "I" class motor, RF remote and charger. \$2,855.00.00 for the first 4 ft. Each additional foot \$81.25. Freight not included.

Other components at an additional cost.

First 48"	60"	72"	84"	96"	108"	120"	132"
\$2,855.00	\$2,936.25	\$3,017.50	\$3,098.75	\$3,180.00	\$3,261.25	\$3,342.50	\$3,423.75
144"	156"	168"	180"	192"	204"	216"	228"
\$3,505.00	\$3,586.25	\$3,667.50	\$3,748.75	\$3,830.00	\$3,911.25	\$3,992.50	\$4,073.75

# PORTO COLLECTION

## 1 1/16" DECORATIVE CORDED RAIL



### AVAILABLE FINISHES

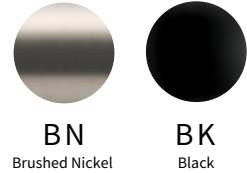

**BN**  
Brushed Nickel

**BK**  
Black

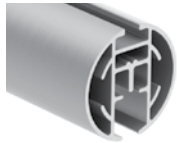

Profile

**POR840-XX**  
Porto Rail 19'7"  
\$48.47/ft.

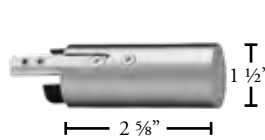

**POR141-XX**  
Decorative Cord Pulley  
\$156.54 ea.

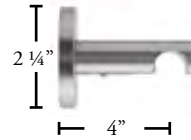

**POR241-XX**  
Single Wall Bracket  
\$165.81 ea.

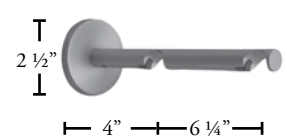

**POR243-XX**  
Double Wall Bracket  
\$202.66 ea.

### PRODUCT INFORMATION

- Material: Aluminum
- Components material: Brass
- Collection style: Modern/Contemporary
- Max length available in one piece: 233"
- Brackets: Recommended every 3-5 feet depending on fabric weight
- Cannot be curved nor bent
- Splice not recommended for one-way draw
- No finials available

### STYLES

- Pinch pleat
- Ripplefold\*
- FlexWave

### APPLICATIONS

- Center draw
- One-way draw
- Off-center draw

### ASSEMBLED PRICING

Single set pricing includes: rail cut to size, end cap pulleys, carriers, masters, cord and single brackets. \$1,179.00 for the first 4 ft. Each additional foot \$119.00. Freight not included.

First 48"	60"	72"	84"	96"	108"	120"	132"
\$1,179.00	\$1,298.00	\$1,417.00	\$1,536.00	\$1,655.00	\$1,774.00	\$1,893.00	\$2,012.00
144"	156"	168"	180"	192"	204"	216"	228"
\$2,131.00	\$2,250.00	\$2,369.00	\$2,488.00	\$2,607.00	\$2,726.00	\$2,845.00	\$2,964.00

# BONN COLLECTION

## 1 9/16" DECORATIVE MOTORIZED RAIL



### AVAILABLE FINISHES

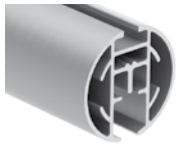
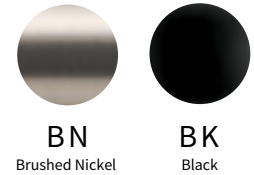

Profile



**BON541-XX**  
Left Motor Pulley  
**BON542-XX**  
Right Motor Pulley  
\$607.36 ea.

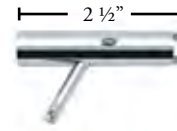

**BON548-XX**  
Left Return Pulley  
**BON549-XX**  
Right Return Pulley  
\$281.76 ea.

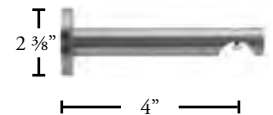

**BON242-XX**  
Single Wall Bracket  
\$165.81 ea.

**BON840-XX**  
Bonn Rail 19'7"  
\$54.96/ft.

### ASSEMBLED PRICING "S" MOTOR

Includes: rail cut to size and assembled, mounting brackets, "S" class motor, RF remote and power supply. \$3,238.00 for the first 4 ft. Each additional foot \$169.00. Add \$225.00 for HD Motor "M" class. Freight not included. Other components at an additional cost.

First 48"	60"	72"	84"	96"	108"	120"	132"
\$3,238.00	\$3,407.00	\$3,576.00	\$3,745.00	\$3,914.00	\$4,083.00	\$4,252.00	\$4,421.00
144"	156"	168"	180"	192"	204"	216"	228"
\$4,590.00	\$4,759.00	\$4,928.00	\$5,097.00	\$5,266.00	\$5,435.00	\$5,604.00	\$5,773.00



**M6S939-WH**  
Motor "S" class with RF  
Built-in Receiver  
\$920.27 ea.



**RFC15-WH**  
RF Multi Remote 15 ch.  
\$368.59 ea.



**RFW02-WH**  
RF Wireless Wall Switch  
with 2 Channels  
\$181.42 ea.



**BEXPRO-WH**  
Smart IP Bridge  
for automation

For more information visit [www.angbejar.com](http://www.angbejar.com)

# SOFIA COLLECTION

1 3/8" DECORATIVE ROUND RAIL



## AVAILABLE FINISHES



BK  
Black



BZ  
Bronze



AL  
Aluminum

## PRODUCT INFORMATION

- Material: Aluminum
- Components materials: Aluminum/Steel
- Collection style: Modern/Contemporary
- Max length available in one piece: 196"
- Brackets: Recommended every 3-5 feet depending on fabric weight
- Cannot be curved nor bent
- Splice not recommended for one-way draw

## STYLES

- Pinch pleat
- Ripplefold\*
- FlexWave

## APPLICATIONS

- Center draw
- One-way draw
- Off-center draw

## ASSEMBLED PRICING

Includes: rail cut to size, end cap finials, single brackets, carriers, masters and 36" fiberglass baton. \$587.00 for the first 4 ft. Each additional foot \$79.00. Freight not included. **\*Above 196" long must be spliced.**

First 48"	60"	72"	84"	96"	108"	120"	132"
\$587.00	\$666.00	\$745.00	\$824.00	\$903.00	\$982.00	\$1,061.00	\$1,140.00
144"	156"	168"	180"	192"	*204"	*216"	*228"
\$1,219.00	\$1,298.00	\$1,377.00	\$1,456.00	\$1,535.00	\$1,614.00	\$1,693.00	\$1,772.00



## COMPONENTS

### Finial



**SOF840-XX**  
Sofia Rail 16'4"  
\$30.50/ft.

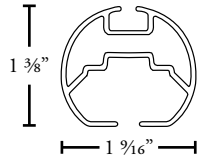

Profile

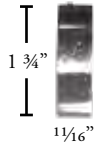

**SOF141-SS**  
Sofia End Cap  
\$40.60 ea.

### Brackets

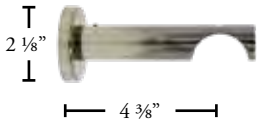

**SOF251-SS**  
Single Wall Bracket  
\$94.35 ea.



**SOF250-SS**  
Bracket Adaptor  
\$28.92 ea.

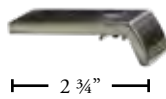

**SOF255-SS**  
Ceiling Bracket  
\$41.56 ea.

### Other Components



**RCARS60-WH** 60% Fullness  
**RCARS80-WH** 80% "  
**RCARS100-WH** 100% "  
**RCARS120-WH** 120% "  
2 piece Connected Snap  
\$1.02 ea. 500/roll



**BCAR02-WH**  
Slim Ball Bearing  
\$0.58 ea. 1000/box



**RMAS301-WH** Over R  
**RMAS302-WH** Under L  
Ripplefold Master w/  
Snaps and Adaptor  
\$7.60 ea. 100/box



**PMAS101-WH** Over R  
**PMAS102-WH** Under L  
Pinch Pleat Master  
Multifunctional  
\$6.01 ea. 100/box

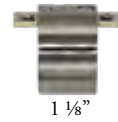

**SOF601-SS**  
Decorative Splice  
\$47.51 ea.



### ASSEMBLED PRICING FOR CORDED RAIL

Includes: rail cut to size, end cap finials, single brackets, carriers, masters, cord, cord pulley and tension pulley.  
\$672.00 for the first 4 ft. Each additional foot \$85.50. Freight not included. **\*Above 196" long must be spliced.**

First 48"	60"	72"	84"	96"	108"	120"	132"
\$672.00	\$757.50	\$843.00	\$928.50	\$1,014.00	\$1,099.50	\$1,185.00	\$1,270.50
144"	156"	168"	180"	192"	*204"	*216"	*228"
\$1,356.00	\$1,441.50	\$1,527.00	\$1,612.50	\$1,698.00	\$1,783.50	\$1,869.00	\$1,954.50

For more information visit [www.angbejar.com](http://www.angbejar.com)

# OXFORD COLLECTION

## 1 3/8" DECORATIVE RAIL



### AVAILABLE FINISHES



**BN**  
Brushed Nickel



**PL**  
Platinum



**BBK**  
Brushed Black

### PRODUCT INFORMATION

- Material: Aluminum
- Components materials: Aluminum/Steel
- Collection style: Classic/Modern
- Max length available in one piece: 120"
- Brackets: Recommended every 3-5 feet depending on fabric weight
- Splice not recommended for one-way draw

### ASSEMBLED PRICING

- Single set pricing includes: rail cut to size, end cap finials, single brackets, carriers, masters and 36" fiberglass baton. \$540.00 for the first 4 ft. Each additional foot \$70.00. Freight not included. **\*Above 120" long must be spliced.**
- Double set first 4 ft. \$977.00 and each additional foot \$118.00. Freight not included.

### STYLES

- Pinch pleat
- Ripplefold\*
- Cubicle
- FlexWave

### APPLICATIONS

- Center draw
- One-way draw
- Off-center draw

First 48"	60"	72"	84"	96"	108"	120"	*132"
\$540.00	\$610.00	\$680.00	\$750.00	\$820.00	\$890.00	\$960.00	\$1,030.00
*144"	*156"	*168"	*180"	*192"	*204"	*216"	*228"
\$1,100.00	\$1,170.00	\$1,240.00	\$1,310.00	\$1,380.00	\$1,450.00	\$1,520.00	\$1,590.00

## COMPONENTS



**OXF828-XX**  
Oxford Rail 10'  
\$38.90/ft.

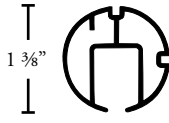

Profile

## Finials



**OXF121-BBK**  
End Cap Finial  
\$41.05 ea.



**OXF121-PL**  
End Cap Finial  
\$41.05 ea.

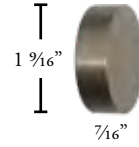

**OXF121-BN**  
End Cap Finial  
\$41.05 ea.

## Brackets

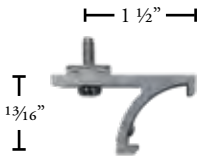

**OXF221-XX**  
Ceiling Bracket  
\$28.12 ea.

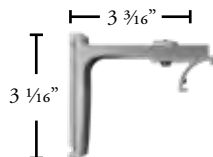

**OXF222-XX**  
Single Wall Bracket  
\$73.48 ea.

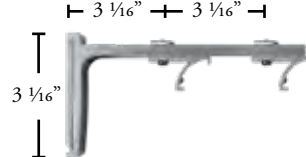

**OXF223-XX**  
Double Wall Bracket  
\$106.37 ea.

## Masters



**RMAS301-WH** Over R  
**RMAS302-WH** Under L  
Ripplefold Master w/  
Snaps and Adaptor  
\$7.60 ea. 100/box



**PMAS101-WH** Over R  
**PMAS102-WH** Under L  
Pinch Pleat Master  
Multifunctional  
\$6.01 ea. 100/box



**BMAS209-WH** Left  
**BMAS210-WH** Right  
Butt w/3 Snaps  
\$14.97 ea. 15/box

## Other Components



**RCARS60-WH** 60% Fullness  
**RCARS80-WH** 80% "  
**RCARS100-WH** 100% "  
**RCARS120-WH** 120% "  
2 piece Connected Snap  
\$1.02 ea. 500/roll



**BCAR02-WH**  
Slim Ball Bearing  
\$0.58 ea. 1000/box



**END307**  
End Lock  
\$0.81 ea. 100/box



For batons see p.126

For more information visit [www.angbejar.com](http://www.angbejar.com)

# CANNES COLLECTION

## 1 1/4" DECORATIVE RAIL

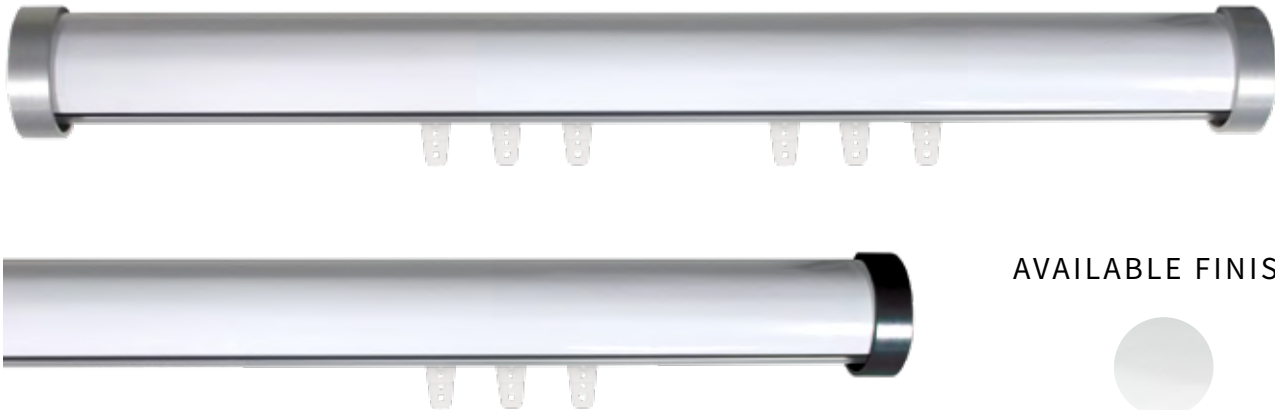

### AVAILABLE FINISH



WH  
White

### PRODUCT INFORMATION

- Material: Aluminum/Wood
- Components materials: Aluminum/Steel
- Collection style: Classic/Modern
- Max length available in one piece: 120"
- Brackets: Recommended every 3-5 feet depending on fabric weight
- Splice not recommended for one-way draw

### STYLES

- Pinch pleat
- Ripplefold\*
- Cubicle
- FlexWave

### APPLICATIONS

- Center draw
- One-way draw
- Off-center draw

### ASSEMBLED PRICING

- Single set pricing includes: rail cut to size, end cap finials, single brackets, carriers, masters and 36" fiberglass baton. \$654.00 for the first 4 ft. Each additional foot \$83.50. Freight not included. **\*Above 120" long must be spliced.**
- Double set first 4 ft. \$1,173.00 and each additional foot \$148.00. Freight not included.

First 48"	60"	72"	84"	96"	108"	120"	*132"
\$654.00	\$737.50	\$821.00	\$904.50	\$988.00	\$1,071.50	\$1,155.00	\$1,238.50
*144"	*156"	*168"	*180"	*192"	*204"	*216"	*228"
\$1,322.00	\$1,405.50	\$1,489.00	\$1,572.50	\$1,656.00	\$1,739.50	\$1,823.00	\$1,906.50

## COMPONENTS



**CAN828-XX**  
Canes Rail 10'  
\$46.61/ft.

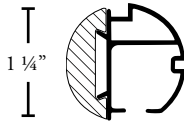

Profile

## Finials

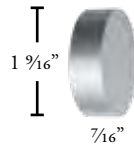

**CAN121-XX**  
End Cap Finial  
\$41.05 ea.



**CAN122-BBK**  
End Cap Finial  
\$41.05 ea.

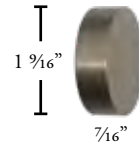

**CAN122-BN**  
End Cap Finial  
\$41.05 ea.

## Brackets

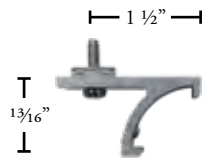

**CAN221-XX**  
Ceiling Bracket  
\$28.12 ea.

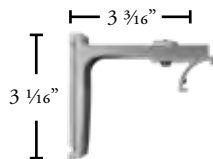

**CAN222-XX**  
Single Wall Bracket  
\$73.48 ea.

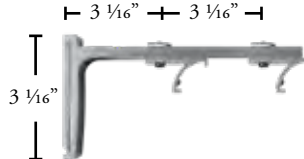

**CAN223-XX**  
Double Wall Bracket  
\$106.37 ea.

## Masters



**RMAS301-WH** Over R  
**RMAS302-WH** Under L  
Ripplefold Master w/  
Snaps and Adaptor  
\$7.60 ea. 100/box



**PMAS101-WH** Over R  
**PMAS102-WH** Under L  
Pinch Pleat Master  
Multifunctional  
\$6.01 ea. 100/box



**BMAS209-WH** Left  
**BMAS210-WH** Right  
Butt w/3 Snaps  
\$14.97 ea. 15/box

## Other Components



**RCARS60-WH** 60% Fullness  
**RCARS80-WH** 80% "  
**RCARS100-WH** 100% "  
**RCARS120-WH** 120% "  
2 piece Connected Snap  
\$1.02 ea. 500/roll



**BCAR02-WH**  
Slim Ball Bearing  
\$0.58 ea. 1000/box



**END307**  
End Lock  
\$0.81 ea. 100/box



For batons see p.126

For more information visit [www.angbejar.com](http://www.angbejar.com)

# VERONA COLLECTION

## 1 3/8" DECORATIVE SQUARE RAIL

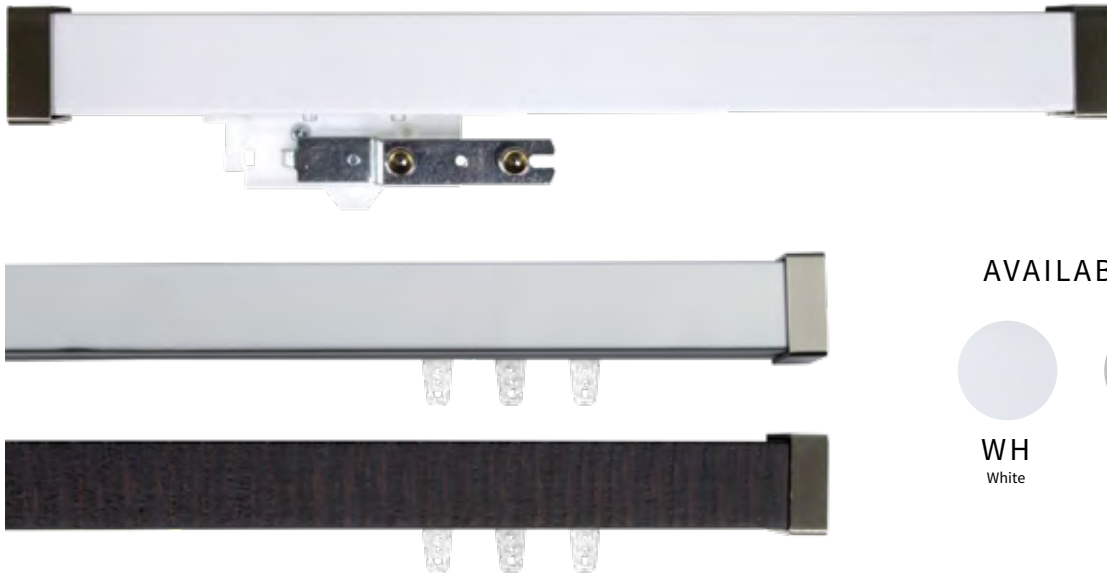

### AVAILABLE FINISHES



### PRODUCT INFORMATION

- Material: Aluminum/Wood
- Components materials: Aluminum/Steel
- Collection style: Classic/Modern
- Max length available in one piece: 96"
- Brackets: Recommended every 3-5 feet depending on fabric weight
- Splice not recommended for one-way draw

### STYLES

- Pinch pleat
- Ripplefold\*
- Cubicle
- FlexWave

### APPLICATIONS

- Center draw
- One-way draw
- Off-center draw

### ASSEMBLED PRICING

- Single set pricing includes: rail cut to size, end cap finials, single brackets, carriers, masters and 36" fiberglass baton. \$654.00 for the first 4 ft. Each additional foot \$83.50. Freight not included. **\*Above 96" long must be spliced.**
- Double set first 4 ft. \$1,173.00 and each additional foot \$148.25. Freight not included.

First 48"	60"	72"	84"	96"	*108"	*120"	*132"
\$654.00	\$737.50	\$821.00	\$904.50	\$988.00	\$1,071.50	\$1,155.00	\$1,238.50
*144"	*156"	*168"	*180"	*192"	*204"	*216"	*228"
\$1,322.00	\$1,405.50	\$1,489.00	\$1,572.50	\$1,656.00	\$1,739.50	\$1,823.00	\$1,906.50

## COMPONENTS



**VER828-XX**  
Verona Rail 8'  
\$46.61/ft.

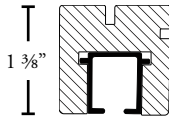

Profile

## Finial

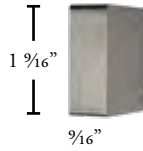

**VER121-XX**  
End Cap Finial  
\$41.05 ea.

## Brackets

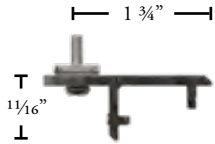

**VER221-XX**  
Ceiling Bracket  
\$28.12 ea.

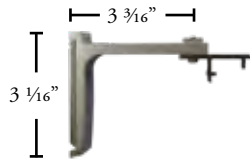

**VER222-XX**  
Single Wall Bracket  
\$73.48 ea.

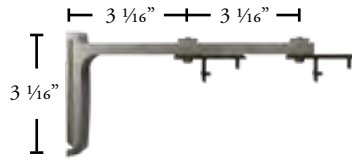

**VER223-XX**  
Double Wall Bracket  
\$106.37 ea.

## Masters



**RMAS301-WH** Over R  
**RMAS302-WH** Under L  
Ripplefold Master w/  
Snaps and Adaptor  
\$7.60 ea. 100/box



**PMAS101-WH** Over R  
**PMAS102-WH** Under L  
Pinch Pleat Master  
Multifunctional  
\$6.01 ea. 100/box



**BMAS209-WH** Left  
**BMAS210-WH** Right  
Butt w/3 Snaps  
\$14.97 ea. 15/box

## Other Components



**RCARS60-WH** 60% Fullness  
**RCARS80-WH** 80% "  
**RCARS100-WH** 100% "  
**RCARS120-WH** 120% "  
2 piece Connected Snap  
\$1.02 ea. 500/roll



**BCAR02-WH**  
Slim Ball Bearing  
\$0.58 ea. 1000/box



**END307**  
End Lock  
\$0.81 ea. 100/box



For batons see p.126

For more information visit [www.angbejar.com](http://www.angbejar.com)

# LIVERPOOL COLLECTION

## DECORATIVE SQUARE RAIL



### AVAILABLE FINISHES



**BK**  
Black

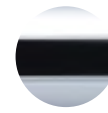

**PC**  
Polished Chrome

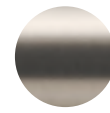

**BN**  
Brushed Nickel

### PRODUCT INFORMATION

- Material: Aluminum
- Components material: Brass/Aluminum
- Collection style: Modern/Contemporary
- Max length available in one piece: 228"
- Brackets: Recommended every 3-5 feet depending on fabric weight
- Cannot be curved nor bent
- Splice not recommended for one-way draw

### STYLES

- Pinch pleat
- Ripplefold\*
- Cubicle
- FlexWave

### APPLICATIONS

- Center draw
- One-way draw
- Off-center draw

### ASSEMBLED PRICING

Single set pricing includes: rail cut to size, end cap finials, single brackets, carriers, masters and 36" fiberglass baton. \$822.00 for the first 4 ft. Each additional foot \$159.00. Freight not included.

First 48"	60"	72"	84"	96"	108"	120"	132"
\$822.00	\$981.00	\$1,140.00	\$1,299.00	\$1,458.00	\$1,617.00	\$1,776.00	\$1,935.00
144"	156"	168"	180"	192"	204"	216"	228"
\$2,094.00	\$2,253.00	\$2,412.00	\$2,571.00	\$2,730.00	\$2,889.00	\$3,048.00	\$3,207.00



## COMPONENTS



**LIV838-XX**  
Liverpool Rail 19.7'  
\$53.94/ft.

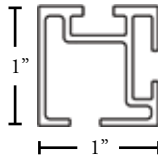

Profile

## Finial

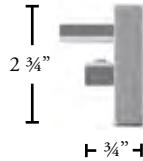

**LIV141-SS**  
End Cap Finial  
\$48.46 ea.

## Brackets

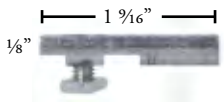

**LIV255-SS**  
Flush Ceiling Bracket  
\$24.97 ea.

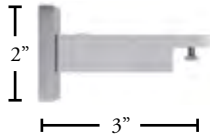

**LIV241-SS**  
Wall Bracket  
\$198.70 ea.

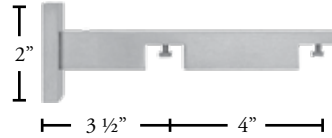

**LIV243-SS**  
Double Wall Bracket  
\$263.47 ea.

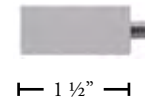

**LIV250-SS**  
Bracket Extension  
\$59.61 ea.

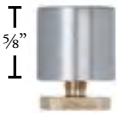

**LIV244-SS**  
Ceiling Bracket  
\$95.37 ea.

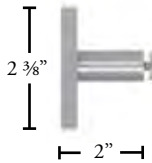

**LIV227-SS**  
Hidden Wall Bracket  
\$217.88 ea.



**RMAS301-WH** Over R  
**RMAS302-WH** Under L  
Ripplefold Master w/Snaps  
and Adaptor  
\$7.60 ea. 100/box



**PMAS101-WH** Over R  
**PMAS102-WH** Under L  
Pinch Pleat Master  
Multifunctional  
\$6.01 ea. 100/box



**BMAS209-WH** Left  
**BMAS210-WH** Right  
Butt w/3 Snaps  
\$14.97 ea. 15/box

## Other Components

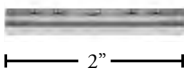

**LIV601-SB**  
Rail Connector  
\$20.73 ea.



**BCAR02-WH**  
Slim Ball Bearing  
\$0.58 ea.



**END306-WH**  
End Stop  
\$0.77 ea.



**RCARS60-WH** 60% Fullness  
**RCARS80-WH** 80% "  
**RCARS100-WH** 100% "  
**RCARS120-WH** 120% "  
2 piece Connected Snap  
\$1.02 ea. 500/roll



**RCARB60-WH** 60% Fullness  
**RCARB80-WH** 80% "  
**RCARB100-WH** 100% "  
**RCARB120-WH** 120% "  
B/B Connected Snap  
\$1.65 ea.

For more information visit [www.angbejar.com](http://www.angbejar.com)

# MONACO COLLECTION

1 5/8" STEEL DECORATIVE FLAT RAIL



AVAILABLE FINISH

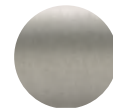

SS

Stainless Steel

## PRODUCT INFORMATION

- Material: Aluminum
- Components material: Steel
- Collection style: Modern/Contemporary
- Max length available in one piece: 228"
- Brackets: Recommended every 3-5 feet depending on fabric weight
- Cannot be curved nor bent
- Splice not recommended for one-way draw

## STYLES

- Pinch pleat
- Ripplefold\*
- Cubicle
- FlexWave

## APPLICATIONS

- Center draw
- One-way draw
- Off-center draw

## ASSEMBLED PRICING

Single set pricing includes: rail cut to size, end cap finials, single brackets, carriers, masters and 36" fiberglass baton. \$535.00 for the first 4 ft. Each additional foot \$111.00. Freight not included.

First 48"	60"	72"	84"	96"	108"	120"	132"
\$535.00	\$646.00	\$757.00	\$868.00	\$979.00	\$1,090.00	\$1,201.00	\$1,312.00
144"	156"	168"	180"	192"	204"	216"	228"
\$1,423.00	\$1,534.00	\$1,645.00	\$1,756.00	\$1,867.00	\$1,978.00	\$2,089.00	\$2,200.00

## COMPONENTS

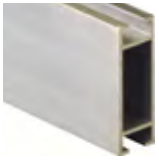

**MON838-ss**  
Monaco Rail 19.7'  
\$33.79/ft.

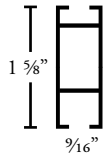

Profile

## Finial

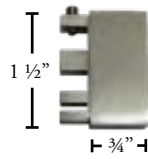

**MON141-SS**  
End Cap Finial  
\$54.09 ea.

## Brackets



**MON241-SS**  
Single Wall Bracket  
\$116.38 ea.

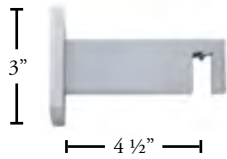

**MON242-SS**  
Single Wall Bracket  
\$133.59 ea.

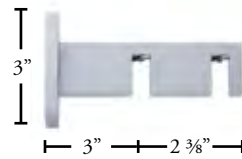

**MON243-SS**  
Double Wall Bracket  
\$161.60 ea.



**MON248-SS**  
Ceiling Bracket  
\$34.87 ea.

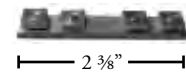

**MON601-SS**  
Rail Connector  
\$21.43 ea.



**KMAS230-WH**  
Plastic Overlap Master for  
Pinch Pleat or Ripplefold  
\$11.14 ea. 25/box



**KMAS240-WH**  
Plastic Underlap Master for  
Pinch Pleat or Ripplefold  
\$11.14 ea. 25/box

## Other Components



**PCAR05**  
Monaco Roller Carrier  
\$1.30 ea.



**PCAR10-WH**  
Nylon Carrier  
\$0.42 ea. 500/box



**END306-WH**  
End Stop  
\$0.77 ea.



**MRC60-WH** 60% Fullness  
**MRC80-WH** 80% "  
**MRC100-WH** 100% "  
**MRC120-WH** 120% "  
2 piece Connected Snap  
\$1.02 ea. 500/roll

For more information visit [www.angbejar.com](http://www.angbejar.com)

# KIEL COLLECTION

## 1 5/8" DECORATIVE FLAT RAIL



### AVAILABLE FINISHES



**BK**  
Black

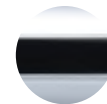

**PC**  
Polished Chrome

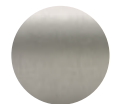

**SN**  
Satin Nickel

### PRODUCT INFORMATION

- Material: Aluminum
- Components material: Brass
- Collection style: Modern/Contemporary
- Max length available in one piece: 228"
- Brackets: Recommended every 3-5 feet depending on fabric weight
- Cannot be curved nor bent
- Splice not recommended for one-way draw

### STYLES

- Pinch pleat
- Ripplefold\*
- Cubicle
- FlexWave

### APPLICATIONS

- Center draw
- One-way draw
- Off-center draw

### ASSEMBLED PRICING

Single set pricing includes: rail cut to size, end cap finials, single brackets, carriers, masters and 36" fiberglass baton. \$862.00 for the first 4 ft. Each additional foot \$185.00. Freight not included.

First 48"	60"	72"	84"	96"	108"	120"	132"
\$862.00	\$1,047.00	\$1,232.00	\$1,417.00	\$1,602.00	\$1,787.00	\$1,972.00	\$2,157.00
144"	156"	168"	180"	192"	204"	216"	228"
\$2,342.00	\$2,527.00	\$2,712.00	\$2,897.00	\$3,082.00	\$3,267.00	\$3,452.00	\$3,637.00

## COMPONENTS

### Finials



Profile

**KIE840-XX**  
Kiel Rectangular Rail 19.7'  
\$43.63/ft.

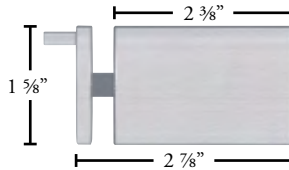

**KIE143-XX**  
Square Finial w/spacer  
\$219.81 ea.

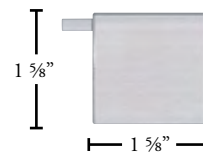

**KIE142-XX**  
Square Finial  
\$127.08 ea.

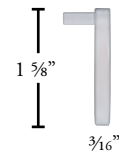

**KIE141-XX**  
End Cap Finial  
\$72.12 ea.

### Brackets

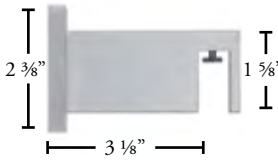

**KIE242-XX**  
Single Wall Bracket  
\$233.54 ea.

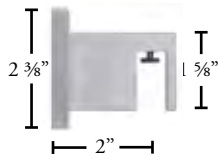

**KIE241-XX**  
Single Wall Bracket  
\$201.33 ea.

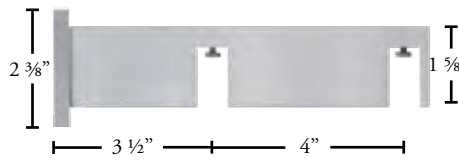

**KIE243-XX**  
Double Wall Bracket  
\$280.24 ea.

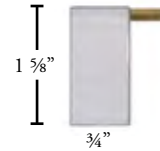

**KIE247-XX**  
Inside Mount Bracket  
\$123.64 ea.

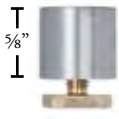

**KIE244-XX**  
Ceiling Bracket  
\$95.37 ea.



**KIE246-AL**  
Ceiling Bracket  
\$24.97 ea.

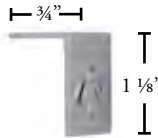

**KIE248-AL**  
Flush Ceiling Bracket  
\$43.66 ea.

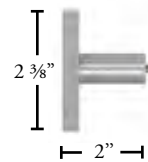

**KIE245-XX**  
Invisible Wall Bracket  
\$217.88 ea.



**KIE601-SB**  
Rail Connector  
\$20.73 ea.

### Other Components



**RCARS60-WH** 60% Fullness  
**RCARS80-WH** 80% "  
**RCARS100-WH** 100% "  
**RCARS120-WH** 120% "  
2 piece Connected Snap  
\$1.02 ea. 500/roll



**BCAR02-WH**  
Slim Ball Bearing  
\$0.58 ea.



**END306-WH**  
End Stop  
\$0.77 ea.



**KMAS230-WH**  
Plastic Overlap Master  
for Pinch Pleat or  
Ripplefold  
\$11.14 ea. 25/box



**KMAS240-WH**  
Plastic Underlap Mas-  
ter for Pinch Pleat or  
Ripplefold  
\$11.14 ea. 25/box

For more information visit [www.angbejar.com](http://www.angbejar.com)

# AVALON COLLECTION

## 2" DECORATIVE RAIL



### PRODUCT INFORMATION

- Material: Aluminum
- Components materials: Aluminum/Steel
- Collection style: Classic/Modern
- Max length available in one piece: 244"
- Brackets: Recommended every 3-5 feet depending on fabric weight
- Cannot be curved nor bent
- Splice not recommended for one-way draw

### ASSEMBLED PRICING

- Single set pricing includes: rail cut to size, end cap finials, single brackets, carriers, masters and 36" fiberglass baton. \$607.00 for the first 4 ft. Each additional foot \$79.00. Freight not included.
- Double set first 4 ft. \$997.00 and each additional foot \$125.50. Freight not included.

### STYLES

- Pinch pleat
- Ripplefold\*
- Cubicle
- FlexWave

### APPLICATIONS

- Center draw
- One-way draw
- Off-center draw

First 48"	60"	72"	84"	96"	108"	120"	132"
\$607.00	\$686.00	\$765.00	\$844.00	\$923.00	\$1,002.00	\$1,081.00	\$1,160.00
144"	156"	168"	180"	192"	204"	216"	228"
\$1,239.00	\$1,318.00	\$1,397.00	\$1,476.00	\$1,555.00	\$1,634.00	\$1,713.00	\$1,792.00

## COMPONENTS

### Finials



**AVA850-XX**  
Avalon Rail 20'  
\$35.72/ft.  
\$54.65/ft. -OA, -WL



Profile

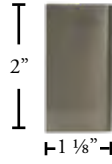

**AVA151-XX**  
Sage Finial  
\$44.79 ea.

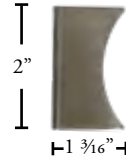

**AVA152-XX**  
Eden Finial  
\$52.39 ea.

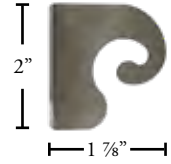

**AVA153-XX**  
Ness Finial  
\$56.36 ea.

### Brackets

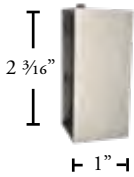

**AVA150-XX**  
End Cap Finial  
\$34.50 ea.



**AVA227-XX**  
Ceiling Bracket  
\$29.60 ea.

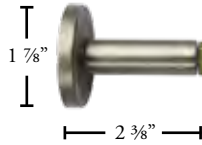

**AVA228-XX**  
Invisible Wall Bracket  
\$56.13 ea.

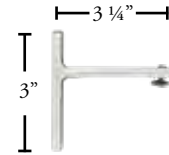

**AVA221-XX**  
Single Wall Bracket  
\$66.34 ea.

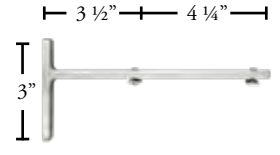

**AVA223-XX**  
Double Wall Bracket  
\$94.01 ea.

### Other Components

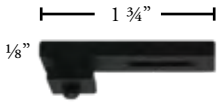

**AVA225-XX**  
Flush Ceiling Bracket  
\$17.75 ea.



**AVA455-XX**  
90° Corner Connector  
\$70.88 ea.



**AVA602-SL**  
Small Mounting Block  
\$1.11 ea.

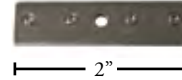

**AVA601-SB**  
Rail Splice Connector  
\$13.55 ea.



**AVA605-SL**  
Extra Long HD Splice  
\$20.30 ea.



### ASSEMBLED PRICING FOR CORDED RAIL

Includes: rail cut to size, end cap finials, single brackets, carriers, masters, cord, cord pulley and tension pulley.  
\$729.00 for the first 4 ft. Each additional foot \$95.00. Freight not included.

First 48"	60"	72"	84"	96"	108"	120"	132"
\$729.00	\$824.00	\$919.00	\$1,014.00	\$1,109.00	\$1,204.00	\$1,299.00	\$1,394.00
144"	156"	168"	180"	192"	204"	216"	228"
\$1,489.00	\$1,584.00	\$1,679.00	\$1,774.00	\$1,869.00	\$1,964.00	\$2,059.00	\$2,154.00

For more information visit [www.angbejar.com](http://www.angbejar.com)

# TURIN COLLECTION

## 2" DECORATIVE RAIL



### AVAILABLE FINISHES



PL  
Platinum



BN  
Brushed Nickel

### PRODUCT INFORMATION

- Material: Aluminum
- Components materials: Aluminum/Steel
- Collection style: Classic/Modern
- Max length available in one piece: 120"
- Brackets: Recommended every 3-5 feet depending on fabric weight
- Splice not recommended for one-way draw

### ASSEMBLED PRICING

- Single set pricing includes: rail cut to size, end cap finials, single brackets, carriers, masters and 36" fiberglass baton. \$595.00 for the first 4 ft. Each additional foot \$77.00. Freight not included. **\*Above 120" long must be spliced.**
- Double set first 4 ft. \$1,089.50 and each additional foot \$134.00. Freight not included.

### STYLES

- Pinch pleat
- Ripplefold\*
- Cubicle
- FlexWave

### APPLICATIONS

- Center draw
- One-way draw
- Off-center draw

First 48"	60"	72"	84"	96"	108"	120"	*132"
\$595.00	\$672.00	\$749.00	\$826.00	\$903.00	\$980.00	\$1,057.00	\$1,134.00
*144"	*156"	*168"	*180"	*192"	*204"	*216"	*228"
\$1,211.00	\$1,288.00	\$1,365.00	\$1,442.00	\$1,519.00	\$1,596.00	\$1,673.00	\$1,750.00



## COMPONENTS



**TUR828-XX**  
Turin Rail 10'  
\$42.75/ft.

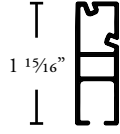

Profile

## Finials

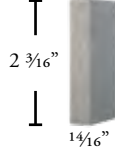

**TUR121-PL**  
End Cap Finial  
\$41.05 ea.

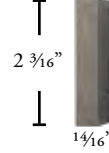

**TUR121-BN**  
End Cap Finial  
\$41.05 ea.

## Brackets

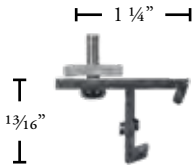

**TUR221-XX**  
Ceiling Wall Bracket  
\$28.12 ea.

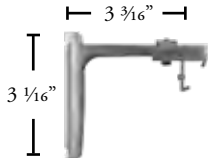

**TUR222-XX**  
Single Wall Bracket  
\$73.48 ea.

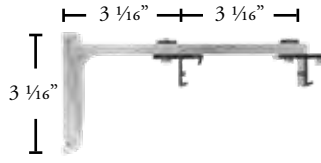

**TUR223-XX**  
Double Wall Bracket  
\$106.37 ea.

## Masters



**RMAS301-WH** Over R  
**RMAS302-WH** Under L  
Ripplefold Master w/  
Snaps and Adaptor  
\$7.60 ea. 100/box



**PMAS101-WH** Over R  
**PMAS102-WH** Under L  
Pinch Pleat Master  
Multifunctional  
\$6.01 ea. 100/box



**BMAS209-WH** Left  
**BMAS210-WH** Right  
Butt w/3 Snaps  
\$14.97ea. 15/box



**BMAS401-WH** Right  
**BMAS402-WH** Left  
Wheeled Butt Master  
\$22.75 ea. 15/box

## Other Components



**RCARS60-WH** 60% Fullness  
**RCARS80-WH** 80% "  
**RCARS100-WH** 100% "  
**RCARS120-WH** 120% "  
2 piece Connected Snap  
\$1.02 ea. 500/roll



**RCARB60-WH** 60% Fullness  
**RCARB80-WH** 80% "  
**RCARB100-WH** 100% "  
**RCARB120-WH** 120% "  
B/B Connected Snap  
\$1.65 ea.



**BCAR02-WH**  
Slim Ball Bearing  
\$0.58 ea. 1000/box



**END307**  
End Lock  
\$0.81 ea. 100/box



For batons see p.126

For more information visit [www.angbejar.com](http://www.angbejar.com)

# BRUSSELS COLLECTION

## 2" DECORATIVE RAIL

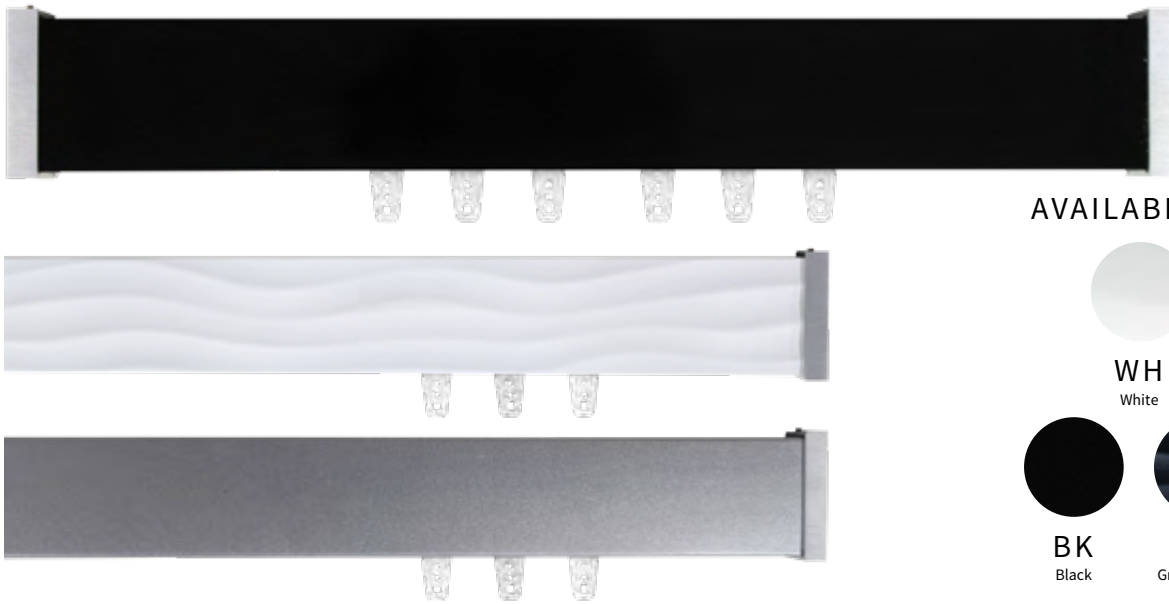

### AVAILABLE FINISHES



### PRODUCT INFORMATION

- Material: Aluminum/Wood
- Components materials: Aluminum/Steel
- Collection style: Classic/Modern
- Max length available in one piece: 96"
- Brackets: Recommended every 3-5 feet depending on fabric weight
- Splice not recommended for one-way draw

### ASSEMBLED PRICING

- Single set pricing includes: rail cut to size, end cap finials, single brackets, carriers, masters and 36" fiberglass baton. \$712.00 for the first 4 ft. Each additional foot \$100.00. Freight not included. **\*Above 96" long must be spliced.**
- Double set first 4 ft. \$1,275.00 and each additional foot \$173.50. Freight not included.

### STYLES

- Pinch pleat
- Ripplefold\*
- Cubicle
- FlexWave

### APPLICATIONS

- Center draw
- One-way draw

First 48"	60"	72"	84"	96"	*108"	*120"	*132"
\$712.00	\$812.00	\$912.00	\$1,012.00	\$1,112.00	\$1,212.00	\$1,312.00	\$1,412.00
*144"	*156"	*168"	*180"	*192"	*204"	*216"	*228"
\$1,512.00	\$1,612.00	\$1,712.00	\$1,812.00	\$1,912.00	\$2,012.00	\$2,112.00	\$2,212.00

## COMPONENTS



**BRU828-XX**  
Brussels Rail 8'  
\$70.85/ ft.

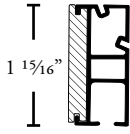

Profile

## Finial

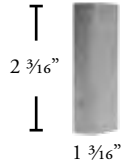

**BRU121-XX**  
End Cap Finial  
\$41.05 ea.

## Brackets

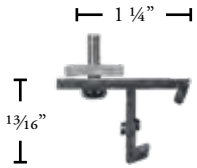

**BRU221-XX**  
Ceiling Bracket  
\$28.12 ea.

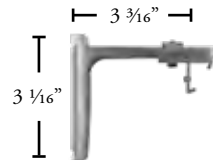

**BRU222-XX**  
Single Wall Bracket  
\$73.48 ea.

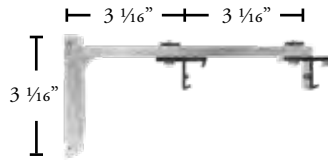

**BRU223-XX**  
Double Wall Bracket  
\$106.37 ea.

## Masters



**RMAS301-WH** Over R  
**RMAS302-WH** Under L  
Ripplefold Master w/  
Snaps and Adaptor  
\$7.60 ea. 100/box



**PMAS101-WH** Over R  
**PMAS102-WH** Under L  
Pinch Pleat Master  
Multifunctional  
\$6.01 ea. 100/box



**BMAS209-WH** Left  
**BMAS210-WH** Right  
Butt w/3 Snaps  
\$14.97ea. 15/box



**BMAS401-WH** Right  
**BMAS402-WH** Left  
Wheeled Butt Master  
\$22.75 ea. 15/box

## Other Components



**RCARS60-WH** 60% Fullness  
**RCARS80-WH** 80%   "  
**RCARS100-WH** 100%   "  
**RCARS120-WH** 120%   "  
2 piece Connected Snap  
\$1.02 ea. 500/roll



**RCARB60-WH** 60% Fullness  
**RCARB80-WH** 80%   "  
**RCARB100-WH** 100%   "  
**RCARB120-WH** 120%   "  
B/B Connected Snap  
\$1.65 ea.



**BCAR02-WH**  
Slim Ball Bearing  
\$0.58 ea. 1000/box



**END307**  
End Lock  
\$0.81 ea. 100/box



For batons see p.126

For more information visit [www.angbejar.com](http://www.angbejar.com)

# BUDAPEST COLLECTION

## 2" DECORATIVE OVAL RAIL

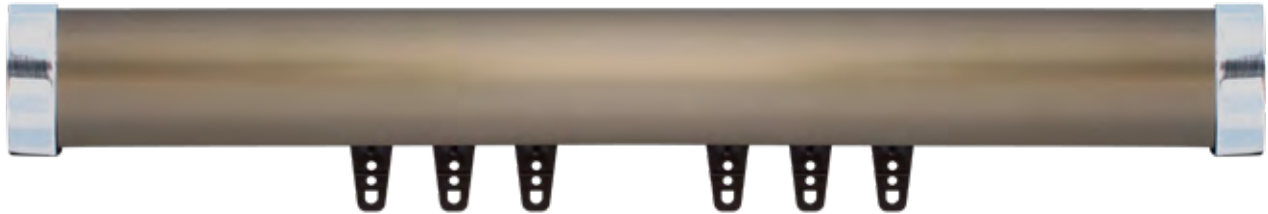

### AVAILABLE FINISHES



BK  
Black



BZ  
Bronze



AL  
Aluminum

### PRODUCT INFORMATION

- Material: Aluminum
- Components materials: Aluminum/Steel
- Collection style: Modern/Contemporary
- Max length available in one piece: 196"
- Brackets: Recommended every 3-5 feet depending on fabric weight
- Cannot be curved nor bent
- Splice not recommended for one-way draw

### STYLES

- Pinch pleat
- Ripplefold\*
- FlexWave

### APPLICATIONS

- Center draw
- One-way draw
- Off-center draw

### ASSEMBLED PRICING

Includes: rail cut to size, end cap finials, single brackets, carriers, masters and 36" fiberglass baton. \$608.00 for the first 4 ft. Each additional foot \$86.50. Freight not included. **\*Above 196" long must be spliced.**

First 48"	60"	72"	84"	96"	108"	120"	132"
\$608.00	\$694.50	\$781.00	\$867.50	\$954.00	\$1,040.50	\$1,127.00	\$1,213.50
144"	156"	168"	180"	192"	*204"	*216"	*228"
\$1,300.00	\$1,386.50	\$1,473.00	\$1,559.50	\$1,646.00	\$1,732.50	\$1,819.00	\$1,905.50

## COMPONENTS



**BUD850-XX**  
Budapest Rail 16'4"  
\$32.04/ft.

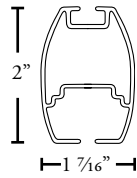

Profile

### Finial



**BUD151-SS**  
Budapest End Cap  
\$42.75 ea.

### Brackets

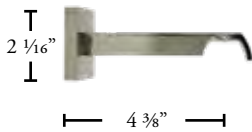

**BUD251-SS**  
Single Wall Bracket  
\$94.35 ea.



**BUD250-SS**  
Bracket Adaptor  
\$28.92 ea.

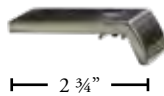

**BUD255-SS**  
Ceiling Bracket  
\$41.50 ea.

### Other Components



**RCARS60-WH** 60% Fullness  
**RCARS80-WH** 80% "  
**RCARS100-WH** 100% "  
**RCARS120-WH** 120% "  
2 piece Connected Snap  
\$1.02 ea. 500/roll



**BCAR02-WH**  
Slim Ball Bearing  
\$0.58 ea. 1000/box



**RMAS301-WH** Over R  
**RMAS302-WH** Under L  
Ripplefold Master w/  
Snaps and Adaptor  
\$7.60 ea. 100/box



**PMAS101-WH** Over R  
**PMAS102-WH** Under L  
Pinch Pleat Master  
Multifunctional  
\$6.01 ea. 100/box

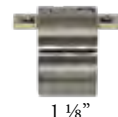

**BUD601-SS**  
Decorative Splice  
\$47.51 ea.

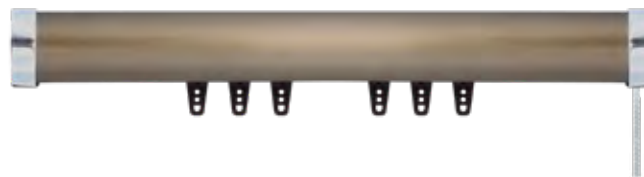

### ASSEMBLED PRICING FOR CORDED RAIL

Includes: rail cut to size, end cap finials, single brackets, carriers, masters, cord, cord pulley and tension pulley.  
\$702.00 for the first 4 ft. Each additional foot \$99.50. Freight not included. **\*Above 196" long must be spliced.**

First 48"	60"	72"	84"	96"	108"	120"	132"
\$702.00	\$801.50	\$901.00	\$1,000.50	\$1,100.00	\$1,199.50	\$1,299.00	\$1,398.50
144"	156"	168"	180"	192"	*204"	*216"	*228"
\$1,498.00	\$1,597.50	\$1,697.00	\$1,796.50	\$1,896.00	\$1,995.50	\$2,095.00	\$2,194.50

For more information visit [www.angbejar.com](http://www.angbejar.com)

# DUBLIN COLLECTION

## 2" DECORATIVE C RAIL

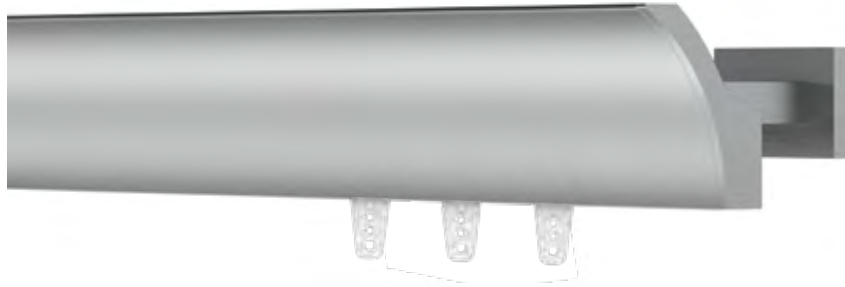

### AVAILABLE FINISHES



**BK**  
Black



**PC**  
Polished Chrome



**BN**  
Brushed Nickel

### PRODUCT INFORMATION

- Material: Aluminum
- Components material: Aluminum/Brass
- Collection style: Modern/Contemporary
- Max length available in one piece: 228"
- Brackets: Recommended every 3-5 feet depending on fabric weight
- Cannot be curved nor bent
- Splice not recommended for one-way draw

### STYLES

- Pinch pleat
- Ripplefold\*
- Cubicle
- FlexWave

### APPLICATIONS

- Center draw
- One-way draw
- Off-center draw

### ASSEMBLED PRICING

Single set pricing includes: rail cut to size, end cap finials, single brackets, carriers, masters and 36" fiberglass baton. \$695.00 for the first 4 ft. Each additional foot \$114.50. Freight not included.

First 48"	60"	72"	84"	96"	108"	120"	132"
\$695.00	\$809.50	\$924.00	\$1,038.50	\$1,153.00	\$1,267.50	\$1,382.00	\$1,496.50
144"	156"	168"	180"	192"	204"	216"	228"
\$1,611.00	\$1,725.50	\$1,840.00	\$1,954.50	\$2,069.00	\$2,183.50	\$2,298.00	\$2,412.50

## COMPONENTS

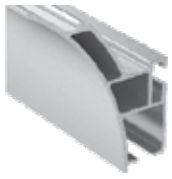

**DUB838-XX**  
Dublin Rail 19.7'  
\$65.98/ft.

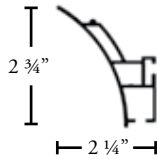

Profile

## Finial

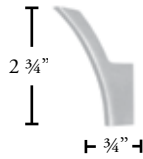

**DUB141-SS**  
End Cap Finial  
\$95.70 ea.

## Brackets



**DUB241-SS**  
Flush Ceiling Bracket  
\$32.05 ea.

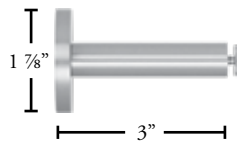

**DUB242-SS**  
Wall Bracket  
\$93.73 ea.

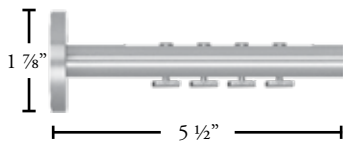

**DUB243-SS**  
Multi Wall Bracket  
\$259.16 ea.

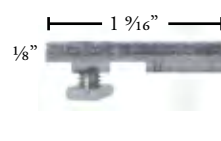

**DUB244-SS**  
Flush Ceiling Bracket  
\$24.97 ea.

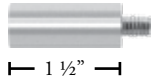

**DUB251-SS**  
Bracket Extension  
\$38.45 ea.



**DUB253-SS**  
Bracket Extension  
\$41.10 ea.



**RMAS301-WH** Over R  
**RMAS302-WH** Under L  
Ripplefold Master w/Snaps  
and Adaptor  
\$7.60 ea. 100/box



**PMAS101-WH** Over R  
**PMAS102-WH** Under L  
Pinch Pleat Master  
Multifunctional  
\$6.01 ea. 100/box



**BMAS209-WH** Left  
**BMAS210-WH** Right  
Butt w/3 Snaps  
\$14.97 ea. 15/box

## Other Components



**DUB601-SB**  
Rail Connector  
\$21.07 ea.



**BCAR02-WH**  
Slim Ball Bearing  
\$0.58 ea.



**END306-WH**  
End Stop  
\$0.77 ea.



**RCARS60-WH** 60% Fullness  
**RCARS80-WH** 80% "  
**RCARS100-WH** 100% "  
**RCARS120-WH** 120% "  
2 piece Connected Snap  
\$1.02 ea. 500/roll

For more information visit [www.angbejar.com](http://www.angbejar.com)

# GALWAY COLLECTION

## 1 1/2" & 2 3/4" DECORATIVE OVAL RAIL



### AVAILABLE FINISHES



**BK**  
Black



**PC**  
Polished Chrome



**BN**  
Brushed Nickel

### PRODUCT INFORMATION

- Material: Aluminum
- Components material: Brass
- Collection style: Modern/Contemporary
- Max length available in one piece: 228"
- Brackets: Recommended every 3-5 feet depending on fabric weight
- Cannot be curved nor bent
- Splice not recommended for one-way draw

### STYLES

- Pinch pleat
- Ripplefold\*
- Cubicle
- FlexWave

### APPLICATIONS

- Center draw
- One-way draw
- Off-center draw

### ASSEMBLED PRICING FOR 1 1/2"

- Single set pricing includes: rail cut to size, end cap finials, single brackets, carriers, masters and 36" fiberglass baton. \$712.50 for the first 4 ft. Each additional foot \$79.00. Freight not included.
- Double set first 4 ft. \$1,392.50 and each additional foot \$149.00. Freight not included.

First 48"	60"	72"	84"	96"	108"	120"	132"
\$712.50	\$791.50	\$870.50	\$949.50	\$1,028.50	\$1,107.50	\$1,186.50	\$1,265.50
144"	156"	168"	180"	192"	204"	216"	228"
\$1,344.50	\$1,423.50	\$1,502.50	\$1,581.50	\$1,660.50	\$1,739.50	\$1,818.50	\$1,897.50



## COMPONENTS



**GAL840-XX**  
Galway 1 1/2" Oval Rail 19.7'  
\$41.64/ft.

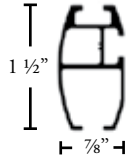

Profile



**GAL141-SS**  
1 1/2" Sona End Cap  
1/4" Projection  
\$76.85 ea.



**GAL870-XX**  
Galway 2 3/4" Oval Rail 19.7'  
\$58.20/ft.

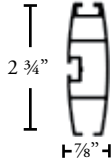

Profile



**GAL171-SS**  
2 3/4" Sona End Cap  
1/4" Projection  
\$98.05 ea.

## Brackets

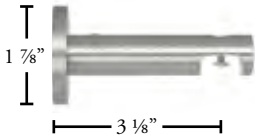

**GAL242-SS**  
Single Wall Bracket  
\$106.00 ea.

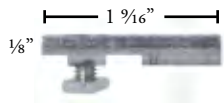

**GAL244-SS**  
Flush Ceiling Bracket  
\$24.97 ea.

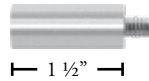

**GAL251-SS**  
Bracket Extension  
\$38.45 ea.

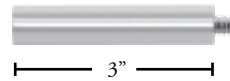

**GAL253-SS**  
Bracket Extension  
\$41.10 ea.



## ASSEMBLED PRICING FOR 2 3/4"

- Single set pricing includes: rail cut to size, end cap finials, single brackets, carriers, masters and 36" fiberglass baton. \$796.25 for the first 4 ft. Each additional foot \$97.50. Freight not included.
- Double set first 4 ft. \$1,580.50 and each additional foot \$189.25. Freight not included.

First 48"	60"	72"	84"	96"	108"	120"	132"
\$796.25	\$893.75	\$991.25	\$1,088.75	\$1,186.25	\$1,283.75	\$1,381.25	\$1,478.75
144"	156"	168"	180"	192"	204"	216"	228"
\$1,576.25	\$1,673.75	\$1,771.25	\$1,868.75	\$1,966.25	\$2,063.75	\$2,161.25	\$2,258.75

For more information visit [www.angbejar.com](http://www.angbejar.com)

# VIENNA COLLECTION

2" & 2 3/4" DECORATIVE WOOD W/TRACK



## AVAILABLE FINISHES



UN  
Unfinished



WH  
White



BK  
Black

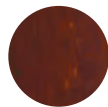

HZ  
Hazel



HN  
Honey

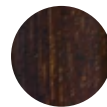

WL  
Walnut



NT  
Natural

## PRODUCT INFORMATION

- Material: Aluminum/Wood
- Components materials: Wood/Plastic/Aluminum
- Collection style: Modern/Contemporary/Classic
- Max length available in one piece: 168"
- Brackets: Recommended every 3-5 feet depending on fabric weight
- Cannot be curved nor bent
- Splice not recommended

## STYLES

- Pinch pleat
- Ripplefold\*
- FlexWave

## APPLICATIONS

- Center draw
- One-way draw
- Off-center draw

## ASSEMBLED PRICING FOR 2"

- Single set pricing includes: routed wood pole and rail cut to size, end cap finials, single brackets, carriers, masters and 36" fiberglass baton. \$423.00 for the first 4 ft. Each additional foot \$40.50. Freight not included.
- Double set first 4 ft. \$458.00 and each additional foot \$52.00. Freight not included.

First 48"	60"	72"	84"	96"	108"	120"	132"
\$423.00	\$463.50	\$504.00	\$544.50	\$585.00	\$625.50	\$666.00	\$706.50
144"	156"	168"	180"	192"	204"	216"	228"
\$747.00	\$787.50	\$828.00	\$868.50	\$909.00	\$949.50	\$990.00	\$1,030.50

\*Unfinished: 10% less

\*\*Corded: 15% more

# COMPONENTS

## Finials



**VIE855-XX**  
Vienna Smooth Pole  
\$20.50/ft. unfinished  
\$26.68/ft. finished



**VIE857-XX**  
Vienna Reeded Pole  
\$24.52/ft. unfinished  
\$29.18/ft. finished



**SMO161-XX**  
Smooth Ball Finial  
\$30.86 ea. unfinished  
\$40.60 ea. finished

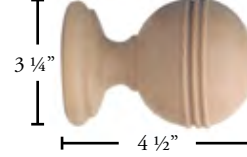

**RIN162-XX**  
Ringed Ball Finial  
\$32.13 ea. unfinished  
\$40.85 ea. finished



**WIN163-XX**  
Windsor Finial  
\$56.60 ea. unfinished  
\$68.96 ea. finished



**END151-XX**  
End Cap Finial  
\$12.10 ea. unfinished  
\$15.12 ea. finished



**FLU152-XX**  
Fluted Ball Finial  
\$46.32 ea. unfinished  
\$57.04 ea. finished

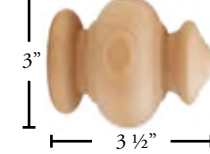

**ODI153-XX**  
Odiseia Finial  
\$32.74 ea. unfinished  
\$48.61 ea. finished



**CAL154-XX**  
Calice Finial  
\$34.07 ea. unfinished  
\$49.85 ea. finished

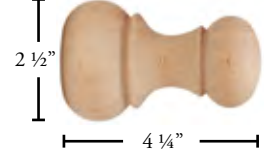

**CAM155-XX**  
Campina Finial  
\$43.31 ea. unfinished  
\$64.41 ea. finished

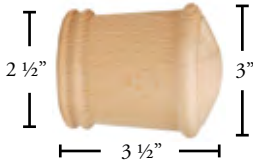

**COR156-XX**  
Corona Finial  
\$31.89 ea. unfinished  
\$47.44 ea. finished

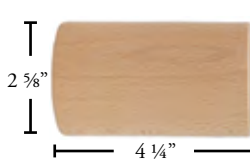

**COU157-XX**  
Country Finial  
\$37.49 ea. unfinished  
\$56.09 ea. finished

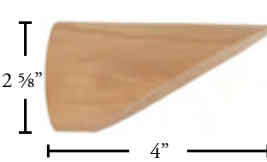

**DEK158-XX**  
Deka Finial  
\$39.44 ea. unfinished  
\$58.57 ea. finished

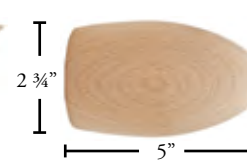

**BAS159-XX**  
Basic Finial  
\$39.44 ea. unfinished  
\$58.57 ea. finished

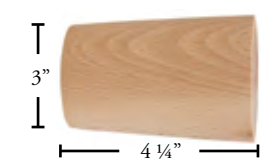

**ZEN160-XX**  
Zenith Finial  
\$38.50 ea. unfinished  
\$57.15 ea. finished

## ASSEMBLED PRICING FOR 2 3/4"

- Single set pricing includes: routed wood pole and rail cut to size, end cap finials, single brackets, carriers, masters and 36" fiberglass baton. \$529.00 for the first 4 ft. Each additional foot \$50.50. Freight not included.
- Double set first 4 ft. \$572.00 and each additional foot \$65.00. Freight not included.

First 48"	60"	72"	84"	96"	108"	120"	132"
\$529.00	\$579.50	\$630.00	\$680.50	\$731.00	\$781.50	\$832.00	\$882.50
144"	156"	168"	180"	192"	204"	216"	228"
\$933.00	\$983.50	\$1,034.00	\$1,084.50	\$1,135.00	\$1,185.50	\$1,236.00	\$1,286.50

- 2 3/4" available finials in Valencia Collection p.120

For more information visit [www.angbejar.com](http://www.angbejar.com)

# LISBOA COLLECTION

## 2" & 2 3/4" DECORATIVE WOOD W/ C-RINGS



### AVAILABLE FINISHES



UN  
Unfinished



WH  
White



BK  
Black



HZ  
Hazel



HN  
Honey

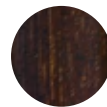

WL  
Walnut



NT  
Natural

### PRODUCT INFORMATION

- Material: Aluminum/Wood
- Components materials: Wood/Plastic/Aluminum
- Collection style: Modern/Contemporary/Classic
- Max length available in one piece: 168"
- Brackets: Recommended every 3-5 feet depending on fabric weight
- Cannot be curved nor bent
- Splice not recommended

### ASSEMBLED PRICING

- Single set pricing includes: routed wood pole and rail cut to size, end cap finials, single brackets, wood c-rings, masters and 36" fiberglass baton. \$627.00 for the first 4 ft. Each additional foot \$67.50. Freight not included.
- Double Set first 4 ft. \$790.00 and each additional foot \$79.50. Freight not included.

### STYLES

- Pinch pleat
- Ripplefold\*
- Cubicle

### APPLICATIONS

- Center draw
- One-way draw
- Off-center draw

First 48"	60"	72"	84"	96"	108"	120"	132"
\$627.00	\$694.50	\$762.00	\$829.50	\$897.00	\$964.50	\$1,032.00	\$1,099.50
144"	156"	168"	180"	192"	204"	216"	228"
\$1,167.00	\$1,234.50	\$1,302.00	\$1,369.50	\$1,437.00	\$1,504.50	\$1,572.00	\$1,639.50

\*Unfinished: 10% less

\*\*Corded: 15% more

## COMPONENTS



**LIS855-XX**  
Lisboa Smooth Pole  
\$20.50/ft. unfinished  
\$26.68/ft. finished



**LIS857-XX**  
Lisboa Reeded Pole  
\$24.52/ft. unfinished  
\$29.18/ft. finished

## Brackets & Masters



**PMAS405** Over R  
**PMAS406** Under L  
Master for C-Rings  
\$7.02 ea.



**WBR80-XX**  
Single Wall Bracket  
\$11.83 ea. (Brown)

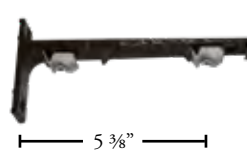

**WBR81-XX**  
Double Wall Bracket  
\$16.96 ea. (Brown)

## Other Components



**LIS370-XX**  
Lisboa C-Ring for 2 3/4"  
wood pole  
\$19.96 ea.



**LIS350-XX**  
Lisboa C-Ring for 2"  
wood pole  
\$9.41 ea.



**END301-BR**  
End Cap w/Slide  
\$1.11 ea. 400/box



**END307-SL**  
End Lock  
\$0.81 ea. 100/box



For batons see p.127

## ASSEMBLED PRICING FOR 2 3/4"

- Single set pricing includes: routed wood pole and rail cut to size, end cap finials, single brackets, wood c-rings, masters and 36" fiberglass baton. \$783.00 for the first 4 ft. Each additional foot \$85.00. Freight not included.
- Double set first 4 ft. \$987.00 and each additional foot \$99.50. Freight not included.

First 48"	60"	72"	84"	96"	108"	120"	132"
\$783.00	\$868.00	\$953.00	\$1,038.00	\$1,123.00	\$1,208.00	\$1,293.00	\$1,378.00
144"	156"	168"	180"	192"	204"	216"	228"
\$1,463.00	\$1,548.00	\$1,633.00	\$1,718.00	\$1,803.00	\$1,888.00	\$1,973.00	\$2,058.00

- **2" available finials in Vienna Collection p.78**
- **2 3/4" available finials in Valencia Collection p.120**

For more information visit [www.angbejar.com](http://www.angbejar.com)

# VENECIA COLLECTION

2" & 2 3/4" DECORATIVE WOOD MOTORIZED

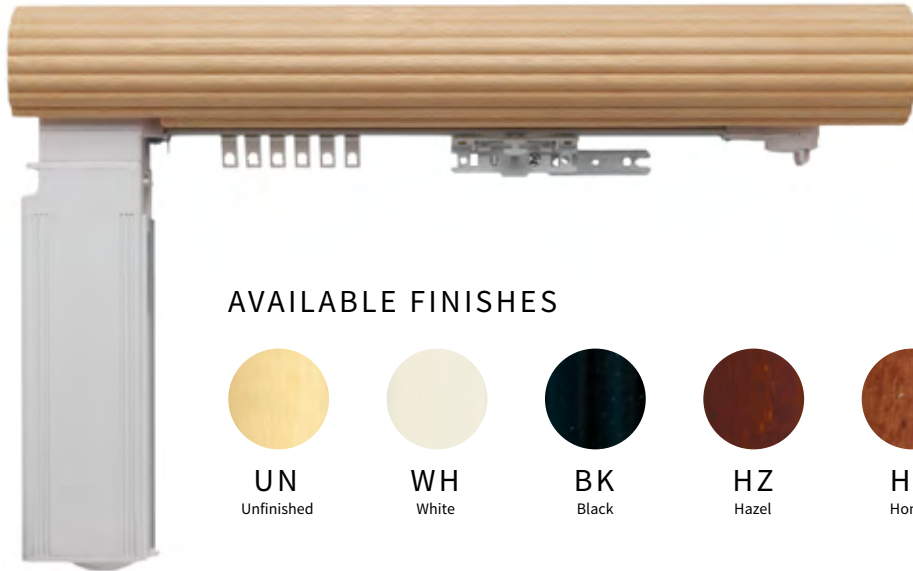

## AVAILABLE FINISHES



**UN**  
Unfinished



**WH**  
White



**BK**  
Black



**HZ**  
Hazel



**HN**  
Honey

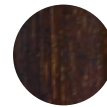

**WL**  
Walnut



**NT**  
Natural

## PRODUCT INFORMATION

- Material: Aluminum/Wood
- Components materials: Wood/Plastic/Aluminum
- Collection style: Modern/Contemporary/Classic
- Max length available in one piece: 168"
- Brackets: Recommended every 3-5 feet depending on fabric weight
- Cannot be curved nor bent
- Splice not recommended
- Uses same motor as M6 Series. More information p.26.
- Somfy motorization available.

## STYLES

- Pinch pleat
- Ripplefold\*
- FlexWave

## APPLICATIONS

- Center draw
- One-way draw
- Off-center draw



**VEN855-XX**  
Venecia Smooth Pole  
\$20.50/ft. unfinished  
\$26.68/ft. finished



**VEN857-XX**  
Venecia Reeded Pole  
\$24.52/ft. unfinished  
\$29.18/ft. finished



**M6S939-WH**  
Motor "S" class with RF  
Built-in Receiver  
\$920.27 ea.



**RFC06-WH**  
RF Multi Remote 15 ch  
\$368.59 ea.



**RWF02-WH**  
RF Wireless Wall Switch  
with 2 Channels  
\$181.42 ea.

## ASSEMBLED PRICING

### 2" WITH "S" MOTOR

Single set pricing includes: 2" routed wood pole, motorized track cut to size and assembled, end cap finials, motor "S" class, power supply, RF remote control. \$1,986.00 for the first 4 ft. Each additional foot \$72.00.

Freight not included. Other components at an additional cost.

First 48"	60"	72"	84"	96"	108"	120"	132"
\$1,986.00	\$2,058.00	\$2,130.00	\$2,202.00	\$2,274.00	\$2,346.00	\$2,418.00	\$2,490.00
144"	156"	168"	180"	192"	204"	216"	228"
\$2,562.00	\$2,634.00	\$2,706.00	\$2,778.00	\$2,850.00	\$2,922.00	\$2,994.00	\$3,066.00

### 2<sup>3</sup>/<sub>4</sub>" WITH "S" MOTOR

Single set pricing includes: 2<sup>3</sup>/<sub>4</sub>" routed wood pole, motorized track cut to size and assembled, end cap finials, motor "S" class, power supply, RF remote control. \$2,383.00 for the first 4 ft. Each additional foot \$87.00.

Freight not included. Other components at an additional cost.

First 48"	60"	72"	84"	96"	108"	120"	132"
\$2,383.00	\$2,470.00	\$2,557.00	\$2,644.00	\$2,731.00	\$2,818.00	\$2,905.00	\$2,992.00
144"	156"	168"	180"	192"	204"	216"	228"
\$3,079.00	\$3,166.00	\$3,253.00	\$3,340.00	\$3,427.00	\$3,514.00	\$3,601.00	\$3,688.00

### 2" WITH "M" MOTOR

Single set pricing includes: 2" routed wood pole, motorized track cut to size and assembled, end cap finials, motor "M" class, power supply, RF remote control. \$2,202.00 for the first 4 ft. Each additional foot \$72.00.

Freight not included. Other components at an additional cost.

First 48"	60"	72"	84"	96"	108"	120"	132"
\$2,202.00	\$2,274.00	\$2,346.00	\$2,418.00	\$2,490.00	\$2,562.00	\$2,634.00	\$2,706.00
144"	156"	168"	180"	192"	204"	216"	228"
\$2,778.00	\$2,850.00	\$2,922.00	\$2,994.00	\$3,066.00	\$3,138.00	\$3,210.00	\$3,282.00

### 2<sup>3</sup>/<sub>4</sub>" WITH "M" MOTOR

Single set pricing includes: 2<sup>3</sup>/<sub>4</sub>" routed wood pole, motorized track cut to size and assembled, end cap finials, motor "M" class, power supply, RF remote control. \$2,598.00 for the first 4 ft. Each additional foot \$87.00.

Freight not included. Other components at an additional cost.

First 48"	60"	72"	84"	96"	108"	120"	132"
\$2,598.00	\$2,685.00	\$2,772.00	\$2,859.00	\$2,946.00	\$3,033.00	\$3,120.00	\$3,107.00
144"	156"	168"	180"	192"	204"	216"	228"
\$3,294.00	\$3,381.00	\$3,468.00	\$3,555.00	\$3,642.00	\$3,729.00	\$3,816.00	\$3,903.00

- **2" available finials in Vienna Collection p.78**
- **2<sup>3</sup>/<sub>4</sub>" available finials in Valencia Collection p.120**

For more information visit [www.angbejar.com](http://www.angbejar.com)





# Decorative Pole Sets

***Beautiful and affordable.*** With a wide variety of pole finishes, revitalizing the décor in any home or office has never been easier.

Our decorative pole sets are available in:

- Wood
- Aluminum
- Stainless steel
- Acrylic
- Wrought iron

From 3/4" in wrought iron and metal to 2 3/4" diameter in wood, AngBéjar carries hundreds of possibilities. All our collections can be customized to fit perfectly in your design. Need a 90" rod? We cut it to size. Need three extra rings? You got it. With AngBéjar, there is no need to absorb wholesale cost.

Our best seller ***Milan Collection*** comes in 14 different finishes and is exemplary of our exclusive European quality.

***New 1 3/8" Decorative Pole - The Rio Collection.*** A popular addition to our decorative pole collections. Comes in 8 different finishes, including an acrylic option.

Our ***Beachfront Collection*** is a powder coated aluminum pole, making it weather resistant for great outdoor use.

Get the beauty and quality you want at an affordable price.

AngBéjar

# MARSEILLE COLLECTION

1/2" DECORATIVE METAL

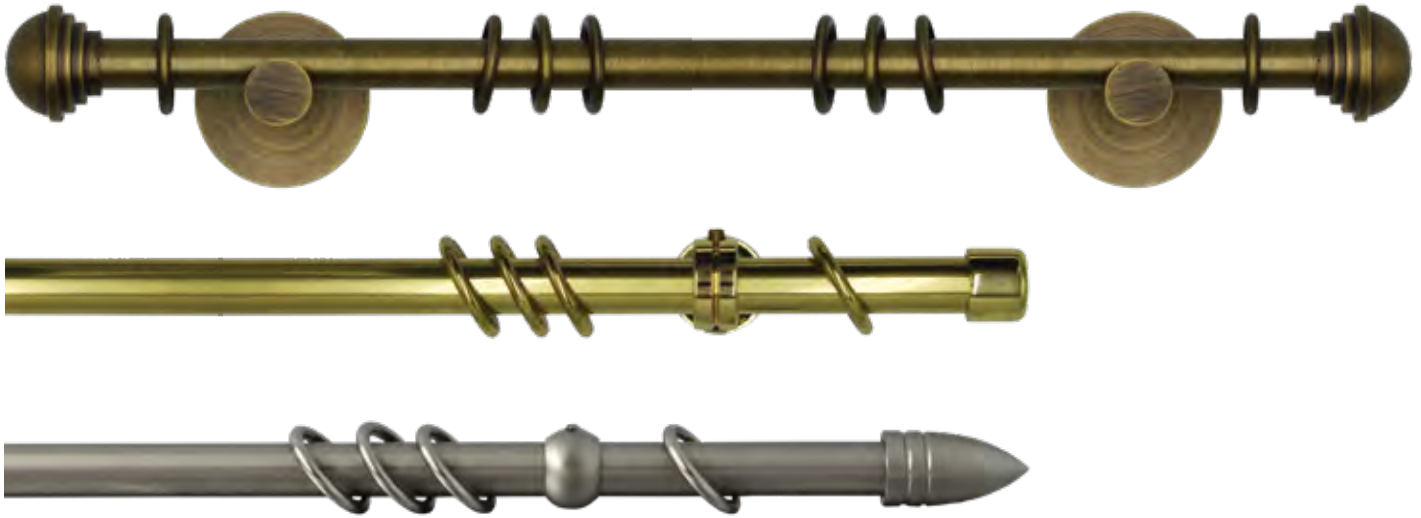

## AVAILABLE FINISHES



PC  
Polished Chrome

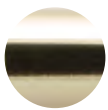

PB  
Polished Brass



BZ  
Bronze



GT  
Graphite



PW  
Pewter

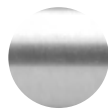

SS  
Stainless Steel

## PRODUCT INFORMATION

- Material: Brass
- Components material: Brass
- Collection style: Modern/Contemporary/Classic
- Max length available in one piece: 196"
- Brackets: Recommended every 3-5 feet depending on fabric weight
- Cannot be curved nor bent
- Can be spliced with bracket

## STYLES

- Decorative Rings
- Grommets
- Pocket

## COMPONENTS



**MAR812-XX**  
Marseille Smooth Pole  
\$21.83/ft.



Profile

## Finials

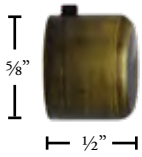

**MAR111-XX**  
End Cap Finial  
\$11.91 ea.

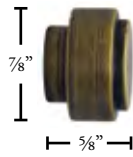

**MAR112-XX**  
Pop Finial  
\$17.34 ea.

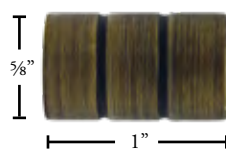

**MAR113-XX**  
Leo Finial  
\$18.84 ea.

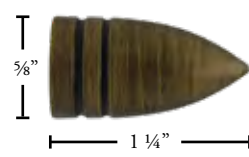

**MAR114-XX**  
Bala Finial  
\$19.46 ea.

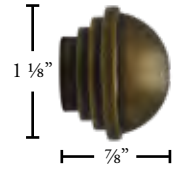

**MAR115-XX**  
Domo Finial  
\$19.02 ea.



**MAR116-XX**  
Velate Finial  
\$18.21 ea.

## Brackets

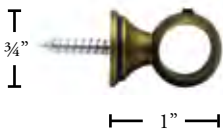

**MAR211-XX**  
Short Closed Bracket  
\$17.71 ea.

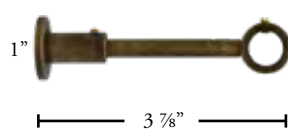

**MAR212-XX \***  
Long Closed Bracket  
\$33.93 ea.

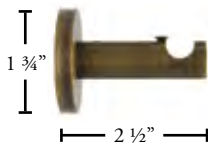

**MAR213-XX**  
Modern Open Bracket  
\$32.41 ea.

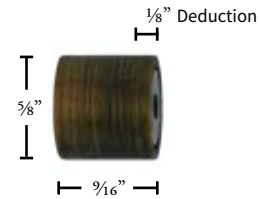

**MAR216-XX**  
Inside Mount Bracket  
\$17.03 ea.

## Other Components

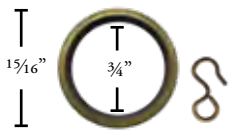

**MAR312-XX**  
Ring w/Eyelet  
\$6.49 ea.

\* Can be cut down.

For more information visit [www.angbejar.com](http://www.angbejar.com)

# SEVILLA COLLECTION

3/4" DECORATIVE METAL



## AVAILABLE FINISHES



PC  
Polished Chrome

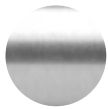

SS  
Stainless Steel



AB  
Antique Bronze

## PRODUCT INFORMATION

- Material: Steel
- Components material: Steel
- Collection style: Modern/Contemporary/Classic
- Max length available in one piece: 118"
- Brackets: Recommended every 3-5 feet depending on fabric weight
- Cannot be curved nor bent
- Can be spliced with bracket

## STYLES

- Decorative Rings
- Grommets
- Pocket

## COMPONENTS



**SEV820-XX**  
Sevilla Smooth Pole 9'10"  
\$21.31/ft.

Profile

## Finials



**SEV121-XX**  
End Cap Finial  
\$18.16 ea.

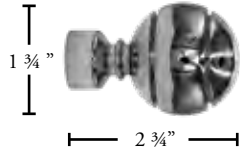

**SEV122-XX**  
Ball Finial  
\$39.89 ea.

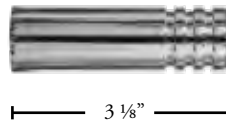

**SEV123-XX**  
Cylinder Finial  
\$40.36 ea.

## Brackets

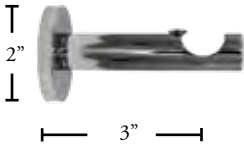

**SEV221-XX**  
Single Wall Bracket  
\$50.60 ea.



**SEV229-XX**  
Ceiling Bracket  
\$49.41 ea.



**SEV226-XX**  
Recess Bracket  
\$29.17 ea.

## Other Components

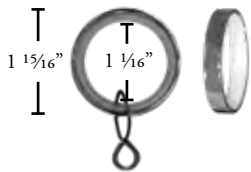

**SEV320-XX**  
Flat Ring  
\$7.03 ea.



**SEV601**  
Splice  
\$14.78 ea.

For more information visit [www.angbejar.com](http://www.angbejar.com)

# PARIS COLLECTION

3/4" DECORATIVE METAL



## AVAILABLE FINISHES



PC  
Polished Chrome



SN  
Satin Nickel



SB  
Satin Brass



BM  
Bronze Matte

## PRODUCT INFORMATION

- Material: Brass
- Components material: Brass
- Collection style: Modern/Contemporary/Classic
- Max length available in one piece: 192"
- Brackets: Recommended every 3-5 feet depending on fabric weight
- Cannot be curved nor bent
- Can be spliced with bracket

## STYLES

- Decorative Rings
- Grommets
- Pocket

## COMPONENTS



**PAR820-XX**  
Paris Smooth Pole 16'4"  
\$25.62/ft.

Profile

## Finials

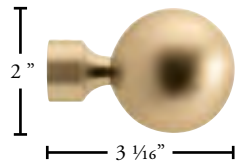

**PAR124-XX**  
Alassio Finial  
\$168.83 ea.



**PAR127-XX**  
Alea Finial  
\$25.30 ea.

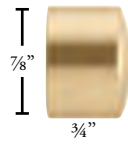

**PAR121-XX**  
End Cap Finial  
\$41.99 ea.

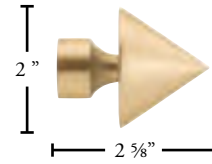

**PAR122-XX**  
Riva Finial  
\$136.51 ea.

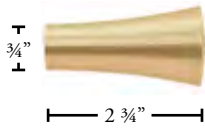

**PAR126-XX**  
Selva Finial  
\$126.44 ea.

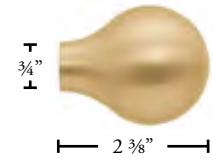

**PAR127-XX**  
Gota Finial  
\$154.89 ea.

## Brackets

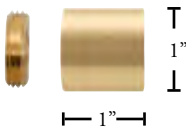

**PAR226-XX**  
Inside Mount Bracket  
\$77.00 ea.

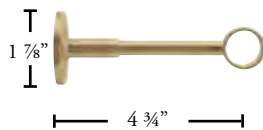

**PAR221-XX**  
Single Bracket  
\$143.51 ea.

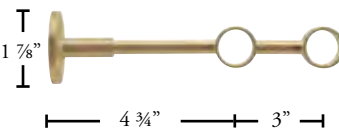

**PAR223-XX**  
Double Bracket  
\$217.00 ea.

## Other Components

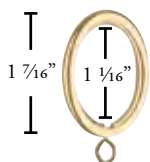

**PAR320-XX**  
Ring w/Eyelet  
\$8.82 ea.



**PAR410-XX**  
Swivel Elbow  
\$171.49 ea.



**PAR601**  
Splice  
\$14.78 ea.

For more information visit [www.angbejar.com](http://www.angbejar.com)

# WESTPORT COLLECTION

1 1/8" DECORATIVE METAL



## AVAILABLE FINISHES



WH  
White



CH  
Chrome



BK  
Black



SS  
Stainless Steel

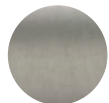

SN  
Satin Nickel



SG  
Satin Gold



BZ  
Bronze



†WL  
Walnut



†OA  
Oak

## PRODUCT INFORMATION

- Material: Aluminum/Steel
- Collection style: Modern/Contemporary/Classic
- Max length available in one piece: 240"
- Brackets: Recommended every 4-6 feet depending on fabric weight
- Cannot be curved nor bent
- Can be spliced with bracket

## STYLES

- Decorative Rings
- Grommets
- Pocket

† Pole Only



## COMPONENTS



**WES828-XX**  
Westport Smooth Pole 20'  
\$22.10/ft.

Profile

### Finials



**WES121-XX**  
End Cap Finial  
\$17.27 ea.

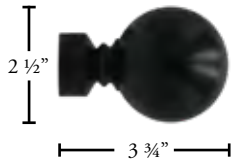

**WES122-XX**  
Lazio Finial  
\$42.75 ea.

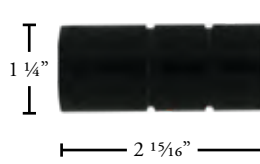

**WES123-XX**  
Westin Finial  
\$42.75 ea.

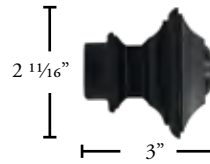

**WES124-XX**  
Zeus Finial  
\$47.04 ea.



**WES125-XX**  
Aspen Finial  
\$47.04 ea.

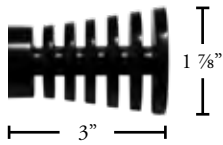

**WES126-XX**  
Naxos Finial  
\$49.33 ea.

### Brackets

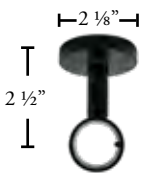

**WES221-XX**  
Closed Ceiling Bracket  
\$36.06 ea.

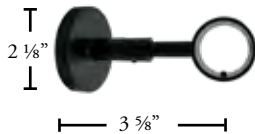

**WES222-XX**  
Closed Wall Bracket  
\$42.41 ea.

### Other Components

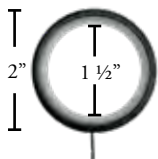

**WES328-XX**  
Ring w/Eyelet  
\$5.22 ea.



**WES335-XX**  
Flat Ring  
\$10.90 ea.



**WES601**  
Splice  
\$14.78 ea.

For more information visit [www.angbejar.com](http://www.angbejar.com)

# LONDON COLLECTION

1 1/8" DECORATIVE METAL



## AVAILABLE FINISHES



PC  
Polished Chrome



SN  
Satin Nickel



SB  
Satin Brass



BM  
Bronze Matte

## PRODUCT INFORMATION

- Material: Brass
- Components material: Brass
- Collection style: Modern/Contemporary/Classic
- Max length available in one piece: 192"
- Brackets: Recommended every 3-5 feet depending on fabric weight
- Cannot be curved nor bent
- Can be spliced with bracket

## STYLES

- Decorative Rings
- Grommets
- Pocket



## COMPONENTS

### Finials



**LON828-XX**  
London Smooth Pole 16'4"  
\$29.12/ft.



Profile

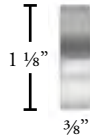

**LON125-XX**  
Alea Finial  
\$69.54 ea.

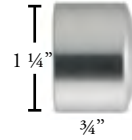

**LON121-XX**  
End Cap Finial  
\$49.00 ea.

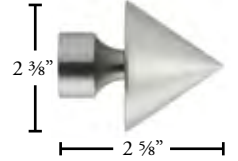

**LON122-XX**  
Riva Finial  
\$230.98 ea.

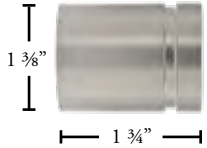

**LON133-XX**  
Terra Finial  
\$112.83 ea.

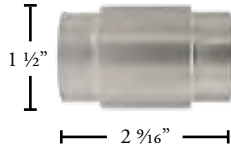

**LON134-XX**  
Tahoe Finial  
\$144.13 ea.

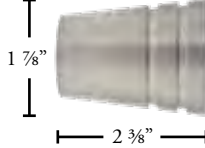

**LON135-XX**  
Zena Finial  
\$140.50 ea.

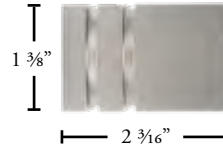

**LON136-XX**  
Edil Finial  
\$147.14 ea.

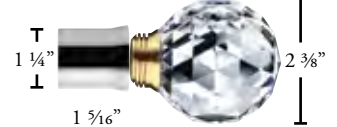

**LON131-XX**  
Ardea Finial  
\$467.70 ea.

**LON132-XX**  
Socket for Ardea Finial  
\$94.04 ea.

### Brackets

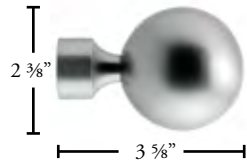

**LON124-XX**  
Alassio Finial  
\$279.97 ea.



**LON127-XX**  
Napoli Finial  
\$347.73 ea.

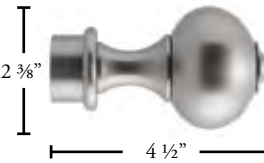

**LON126-XX**  
Verona Finial  
\$379.32 ea.

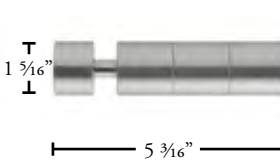

**LON123-XX**  
Pescara Finial  
\$276.50 ea.

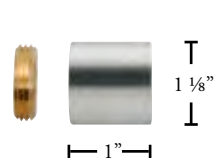

**LON226-XX**  
Inside Mount Bracket  
\$97.99 ea.



**LON240-XX**  
French Return Bracket  
\$178.53 ea.

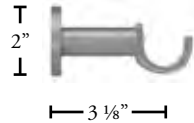

**LON229-XX**  
Support Bracket for French  
Return  
\$174.90 ea.

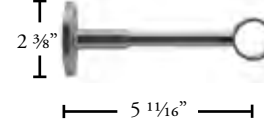

**LON221-XX**  
Single Bracket  
\$227.49 ea.

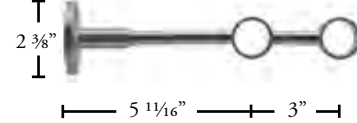

**LON223-XX**  
Double Bracket  
\$314.98 ea.

### Other Components

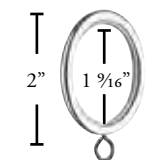

**LON330-XX**  
Ring w/Eyelet  
\$12.30 ea.

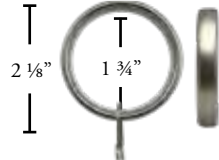

**LON340-XX**  
Modern Ring w/Eyelet  
\$8.51 ea.



**LON410-XX**  
Swivel Elbow  
\$186.29 ea.



**LON601**  
Splice  
\$14.78 ea.

For more information visit [www.angbejar.com](http://www.angbejar.com)

# NEWCASTLE COLLECTION

1 3/16" DECORATIVE METAL



## AVAILABLE FINISHES



PC  
Polished Chrome

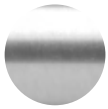

SS  
Stainless Steel



AB  
Antique Bronze

## PRODUCT INFORMATION

- Material: Steel
- Components materials: Steel
- Collection style: Modern/Contemporary/Classic
- Max length available in one piece: 118"
- Brackets: Recommended every 3-5 feet depending on fabric weight
- Cannot be curved nor bent
- Can be spliced with bracket

## STYLES

- Decorative Rings
- Grommets
- Pocket

# COMPONENTS

## Finials



**NCA830-XX**  
Newcastle Metal Pole  
\$26.20/ft.



Profile

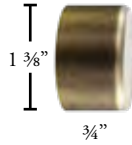

**NCA131-XX**  
End Cap Finial  
\$18.71 ea.



**NCA132-XX**  
Tao Finial  
\$30.96 ea.

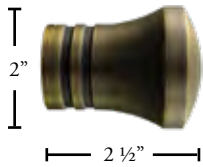

**NCA133-XX**  
Infinite Finial  
\$53.98 ea.

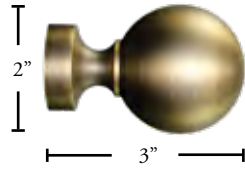

**NCA134-XX**  
Sphere Finial  
\$58.06 ea.

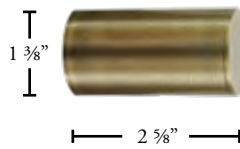

**NCA135-XX**  
Cylinder Finial  
\$51.60 ea.

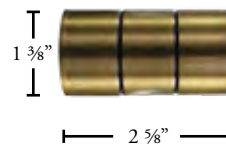

**NCA136-XX**  
Notched Cylinder Finial  
\$51.60 ea.

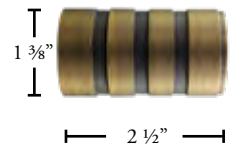

**NCA137-XX**  
Leo Finial  
\$54.66 ea.

## Brackets

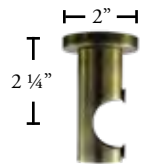

**NCA239-XX**  
Ceiling Bracket  
\$56.89 ea.

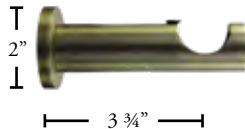

**NCA237-XX**  
Single Wall Bracket  
\$59.99 ea.

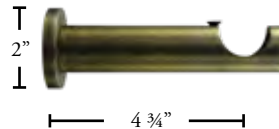

**NCA238-XX**  
Extended Wall Bracket  
\$67.13 ea.

## Other Components

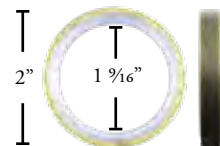

**NCA350-XX**  
Flat Ring w/Eyelet  
\$8.05 ea.



**NCA601**  
Pole Splice  
\$14.78 ea.



For batons see p. 127

For more information visit [www.angbejar.com](http://www.angbejar.com)

# MILAN COLLECTION

1 3/16" DECORATIVE METAL

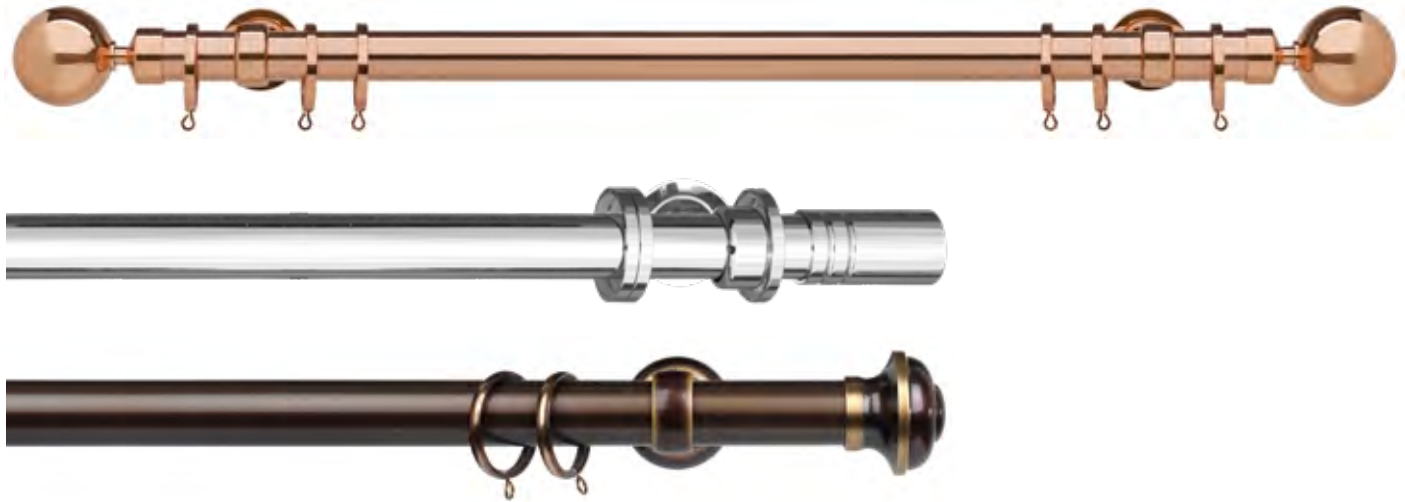

## AVAILABLE FINISHES



## ACRYLIC POLE



## PRODUCT INFORMATION

- Material: Brass/Steel
- Components materials: Brass/Steel
- Collection style: Modern/Contemporary/Classic
- Max length available in one piece: 192"
- Brackets: Recommended every 3-5 feet depending on fabric weight
- Cannot be curved nor bent
- Can be spliced with bracket

## STYLES

- Decorative Rings
- Grommets
- Pocket

# COMPONENTS

## Finials



**MIL830-XX**  
Milan Metal Pole 16'  
\$40.03/ft.



Profile

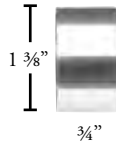

**MIL131-XX**  
End Cap Finial  
\$24.01 ea.

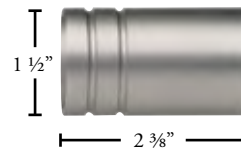

**MIL133-XX**  
Cilindro Finial  
\$67.09 ea.

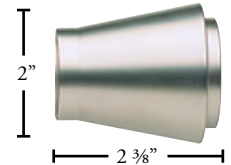

**MIL134-XX**  
Inca Finial  
\$67.39 ea.

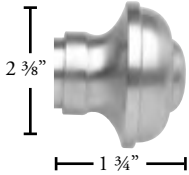

**MIL132-XX**  
Toscana Finial  
\$50.24 ea.

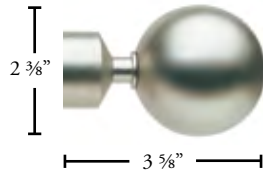

**MIL136-XX**  
Velate Finial  
\$70.85 ea.

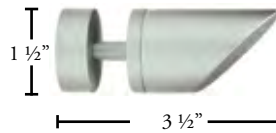

**MIL135-XX**  
Slant Finial  
\$48.71 ea.

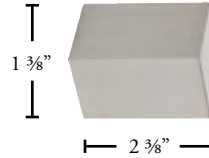

**MIL150-XX**  
Block Finial  
\$60.19 ea.

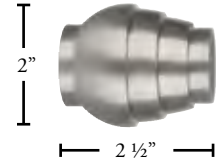

**MIL151-XX**  
Tier Finial  
\$63.61 ea.

## Brackets

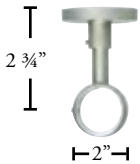

**MIL231-XX**  
Closed Ceiling Bracket  
\$62.80 ea.

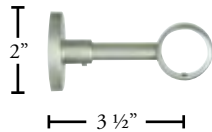

**MIL232-XX**  
Closed Wall Bracket  
\$71.96 ea.

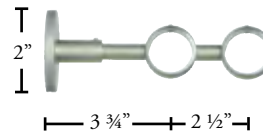

**MIL235-XX**  
Double Closed Bracket  
\$78.50 ea.

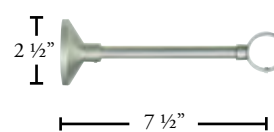

**MIL234-XX**  
Closed Extended Bracket  
\$66.23 ea.

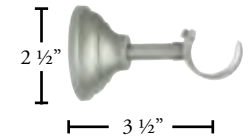

**MIL233-XX**  
Open Wall Bracket  
\$60.57 ea.



**MIL236-XX**  
Open Inside Mount Bracket  
\$34.33 ea.



**MIL240-XX**  
French Return Bracket  
\$73.90 ea.

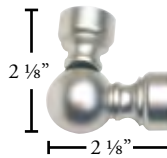

**MIL410**  
Swivel Corner Connector  
\$79.99 ea.

## Other Components



**MIL300-XX**  
Plastic Lined Hollow Ring  
\$5.94 ea.



**MIL350-XX**  
Flat Ring  
\$11.22 ea.



**MIL601**  
Pole Splice  
\$14.78 ea.

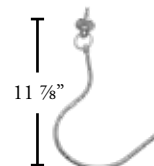

For holdbacks see p. 128



For batons see p. 127

\*Only available in PC and AB finishes

For more information visit [www.angbejar.com](http://www.angbejar.com)

# PRAHA COLLECTION

1 3/16" DECORATIVE STEEL



## AVAILABLE FINISH

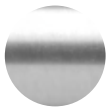

**SS**  
Stainless Steel

## ACRYLIC POLE



**CL**  
Clear

**ACR830-CL**  
Smooth Clear  
Acrylic Pole 19'  
\$31.40/ft.

## PRODUCT INFORMATION

- Pole Material: Stainless Steel A304 quality
- Components material: Steel
- Collection style: Modern/Contemporary
- Max length available in one piece: 228"
- Brackets: Recommended every 3-5 feet depending on fabric weight
- Cannot be curved nor bent
- Can be spliced with bracket
- Not recommended for outdoors

## STYLES

- Decorative Rings
- Grommets
- Pocket



# COMPONENTS



**PRA830-SS**  
 Praha Stainless Steel Pole  
 19' Quality: A304  
 \$40.03/ft.

Profile

## Finials

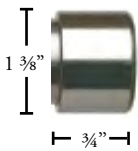

**PRA131-SS**  
 End Cap Finial  
 \$24.01 ea.

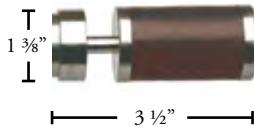

**PRA132-XX**  
 Round Brown (BR)  
 Round Black (BK)  
 \$103.38 ea.

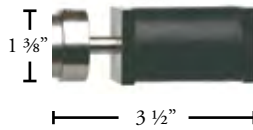

**PRA133-XX**  
 Square Brown (BR)  
 Square Black (BK)  
 \$103.06 ea.

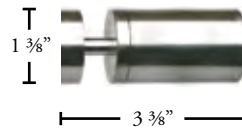

**PRA134-SS**  
 Delta Finial  
 \$78.12 ea.

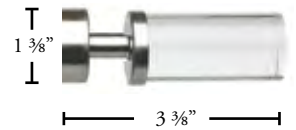

**PRA135-SS**  
 Sydney Finial  
 \$90.74 ea.

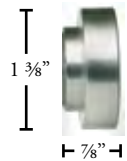

**PRA136-SS**  
 Pop Finial  
 \$58.13 ea.

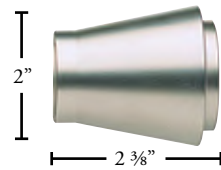

**PRA137-SS**  
 Inca Finial  
 \$67.39 ea.

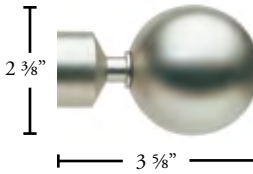

**PRA138-SS**  
 Velate Finial  
 \$70.89 ea.

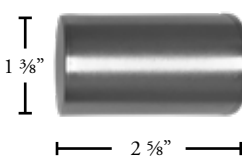

**PRA139-SS**  
 Nova Finial  
 \$66.79 ea.

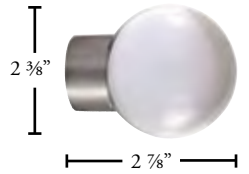

**PRA150-SS**  
 Acrylic Ball Finial  
 \$75.86 ea.

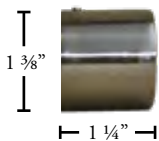

**PRA140-SS**  
 Yale Finial  
 \$16.36 ea.

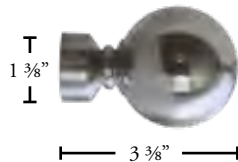

**PRA141-SS**  
 Lazio Finial  
 \$51.68 ea.

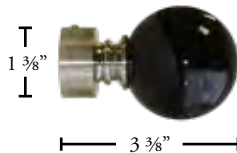

**PRA142-SS**  
 Maya Finial  
 \$94.65 ea.



**PRA143-SS**  
 Niza Finial  
 \$94.65 ea.



**PRA144-SS**  
 Mila Finial  
 \$99.71 ea.

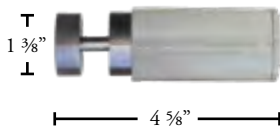

**PRA145-SS**  
 Elsa Finial  
 \$88.41 ea.

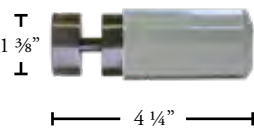

**PRA146-SS**  
 Hex Finial  
 \$91.45 ea.

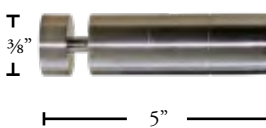

**PRA147-SS**  
 Edin Finial  
 \$78.22 ea.

For more information visit [www.angbejar.com](http://www.angbejar.com)

# COMPONENTS

## Brackets

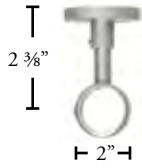

**PRA231-SS**  
Closed Ceiling Bracket  
\$62.80 ea.

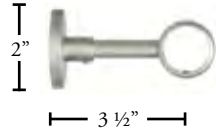

**PRA232-SS**  
Closed Wall Bracket  
\$71.96 ea.

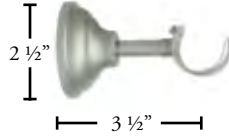

**PRA233-SS**  
Open Bracket  
\$62.05 ea.

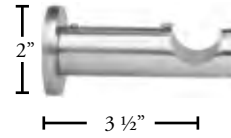

**PRA237-SS**  
Cylinder Wall Bracket  
\$98.39 ea.

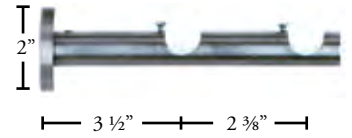

**PRA238**  
Double Cylinder Brackets  
\$160.86 ea.

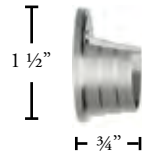

**PRA236-SS**  
Open Inside Mount Bracket  
\$34.33 ea.

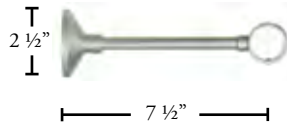

**PRA234-SS**  
Extended Closed Wall Bracket  
\$66.23 ea.

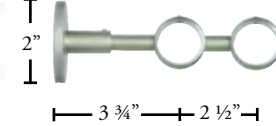

**PRA235-SS**  
Double Closed Wall Bracket  
\$78.50 ea.

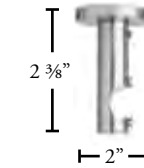

**PRA239-SS**  
Cylinder Ceiling Bracket  
\$109.14 ea.

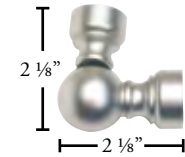

**PRA410-SS**  
Swivel Corner Connector  
\$79.99 ea.

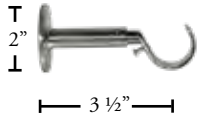

**PRA240-SS**  
Juve Single Wall Bracket  
Adjustable to 5 1/2"  
\$45.13 ea.

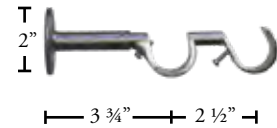

**PRA241-SS**  
Juve Double Wall Bracket  
Adjustable to 5 1/4"  
\$61.63 ea.



**PRA242-SS**  
Juve Ceiling Bracket  
\$43.56 ea.

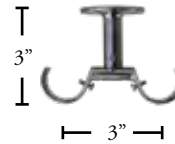

**PRA243-SS**  
Juve Double Ceiling Bracket  
\$59.38 ea.

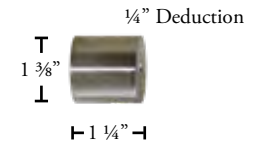

**PRA244-SS**  
Closed Recess Bracket  
\$29.88 ea.

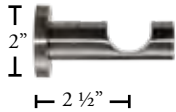

**PRA245-SS**  
Nox Short Single Bracket  
\$79.95 ea.



**PRA246-SS**  
Nox Long Single Bracket  
\$90.89 ea.

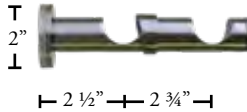

**PRA247-SS**  
Nox Double Wall Bracket  
\$110.19 ea.

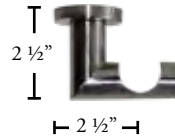

**PRA248-SS**  
Nox Single Ceiling Bracket  
\$87.83 ea.



**PRA249-SS**  
Nox Double Ceiling Bracket  
\$115.14 ea.

## Other Components

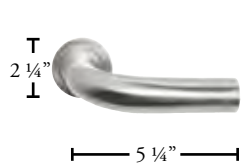

**PRA250-XX**  
French Return Bracket  
\$73.90 ea.

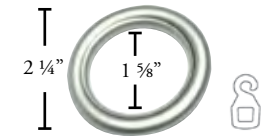

**PRA300-SS**  
Plastic Lined Hollow Ring  
\$6.09 ea.

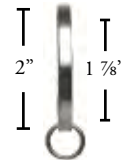

**PRA350-SS**  
Flat Ring  
\$11.22 ea.



**PRA601**  
Pole Splice  
\$14.78 ea.

**MBA240-SS**  
Round Baton 40"  
\$92.26 ea.  
**MBA340-SS**  
Square Baton 40"  
\$97.14 ea.

See more baton options p.127



# FRANKFURT COLLECTION

## 2" DECORATIVE METAL



### AVAILABLE FINISH

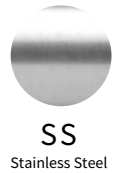

### COMPONENTS



**FRA850-XX**  
Frankfurt Smooth Pole  
\$35.15/ft.



Profile

### Finials

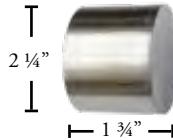

**FRA151-XX**  
End Cap Finial  
\$47.50 ea.



**FRA152-XX**  
Ball Finial  
\$73.46 ea.

### Brackets



**FRA253-XX**  
Wall Bracket  
\$76.92 ea.



**FRA255-XX**  
Ceiling Bracket  
\$82.16 ea.

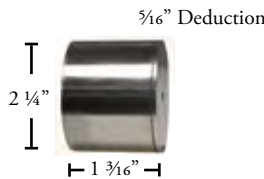

**FRA259-XX**  
Recess Bracket  
\$57.51 ea.

### Other Components



**FRA350-XX**  
Plastic Lined Ring  
\$18.48 ea.



**FRA601**  
Pole Splice  
\$25.36 ea.

### PRODUCT INFORMATION

- Material: Steel
- Components material: Steel
- Collection style: Modern/Contemporary/Classic
- Max length available in one piece: 137"
- Brackets: Recommended every 3-5 feet depending on fabric weight
- Cannot be curved nor bent
- Can be spliced with bracket

### STYLES

- Decorative Rings
- Grommets
- Pocket

For more information visit [www.angbejar.com](http://www.angbejar.com)

# RIO COLLECTION

1 3/8" DECORATIVE METAL

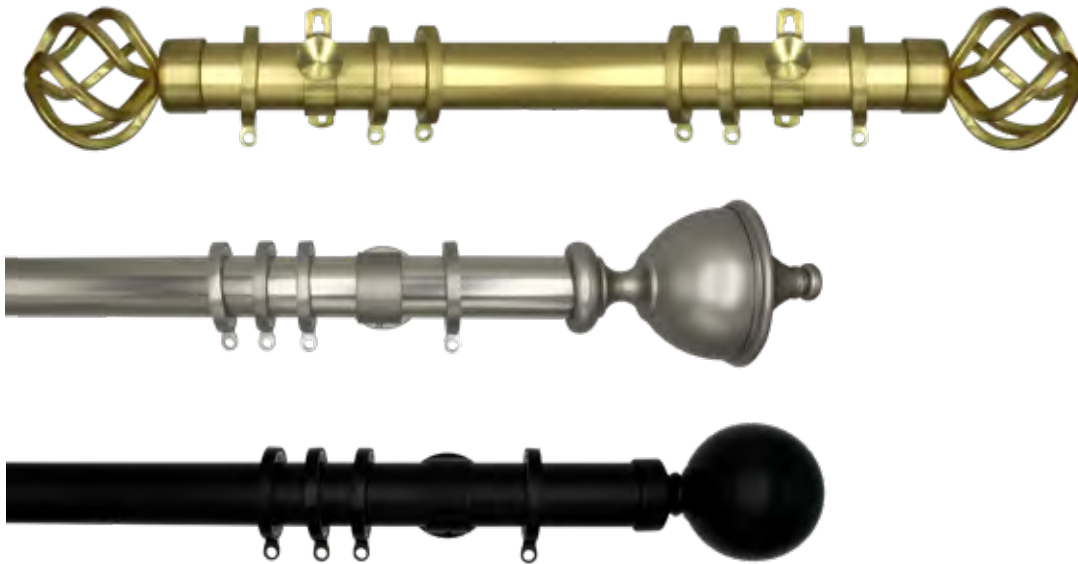

## AVAILABLE FINISHES



PC  
Polished Chrome



BK  
Black



BZ  
Bronze



SB  
Satin Brass

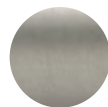

SN  
Satin Nickel

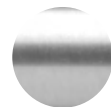

BN  
Brushed Nickel



WH  
White



CL  
Clear

## ACRYLIC POLE

**ACR835-CL**  
Smooth Clear  
Acrylic Pole  
\$36.90/ft.

## PRODUCT INFORMATION

- Material: Steel
- Components material: Steel
- Collection style: Modern/Contemporary/Classic
- Max length available in one piece: 118"
- Brackets: Recommended every 3-5 feet depending on fabric weight
- Cannot be curved nor bent
- Can be spliced with joining bracket

## STYLES

- Decorative Rings
- Grommets
- Pocket

## COMPONENTS



**RIO835-XX**  
Rio Pole 10'  
\$28.90/ft.

Profile

## Finials

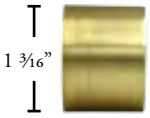

**RIO131-XX**  
Encap Finial  
\$28.50 ea.

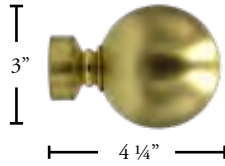

**RIO132-XX**  
Lazio Ball Finial  
\$56.85 ea.



**RIO133-XX**  
Rey Finial  
\$59.20 ea.

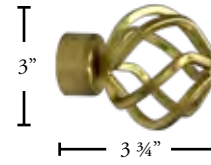

**RIO134-XX**  
Cela Finial  
\$53.10 ea.



**RIO135-XX**  
Sphere Finial  
\$82.50 ea.

## Brackets

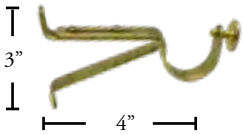

**RIO232-XX**  
Open Bracket  
\$33.70 ea.

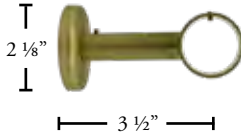

**RIO233-XX**  
Closed Bracket  
\$58.80 ea.

## Other Components

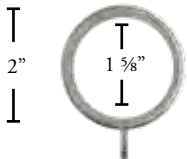

**RIO335-XX**  
Flat Ring  
\$10.90 ea.



**RIO601-XX**  
Pole Splice  
\$14.78 ea.



For batons see p. 127

For more information visit [www.angbejar.com](http://www.angbejar.com)

# OSLO COLLECTION

1 3/8" ACRYLIC POLE



## AVAILABLE FINISHES



PC  
Polished Chrome

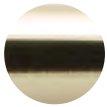

PB  
Polished Brass



GT  
Graphite

## PRODUCT INFORMATION

- Material: Acrylic/Steel
- Components materials: Acrylic/Steel
- Collection style: Modern/Contemporary/Classic
- Max length available in one piece: 228"
- Brackets: Recommended every 3-5 feet depending on fabric weight
- Cannot be curved nor bent
- Can be spliced with joining bracket

## STYLES

- Decorative Rings
- Grommets
- Pocket

### Important Note:

Lighter weight fabric is recommended and extra brackets might be needed.

# COMPONENTS



**OSL835-XX**  
Oslo Acrylic Pole 10'  
\$37.02/ft.

Profile

## Finials

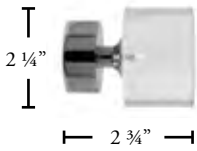

**OSL131-XX**  
Pillbox Finial  
\$115.45 ea.



**OSL132-XX**  
Sphere Finial  
\$147.30 ea.



**OSL133-XX**  
Cylinder Finial  
\$135.36 ea.

## Brackets

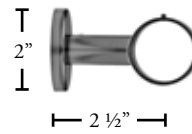

**OSL233-XX**  
Closed Bracket  
\$105.11 ea.

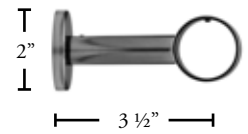

**OSL234-XX**  
Extended Closed Bracket  
\$114.65 ea.

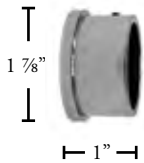

**OSL236-XX**  
Recess Wall Bracket  
\$69.89 ea.

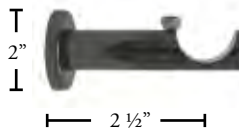

**OSL231-XX**  
Cylinder Bracket  
\$71.23 ea.

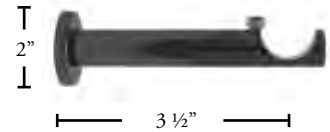

**OSL232-XX**  
Extended Cylinder Bracket  
\$105.11 ea.

## Other Components

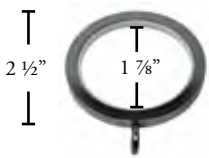

**OSL335-XX**  
Metal Ring w/Eyelet  
\$10.99 ea.



**OSL635-XX**  
Decorative Splice  
\$58.86 ea.



For batons see p. 127

For more information visit [www.angbejar.com](http://www.angbejar.com)

# ESSEN COLLECTION

3/4" DECORATIVE WROUGHT IRON

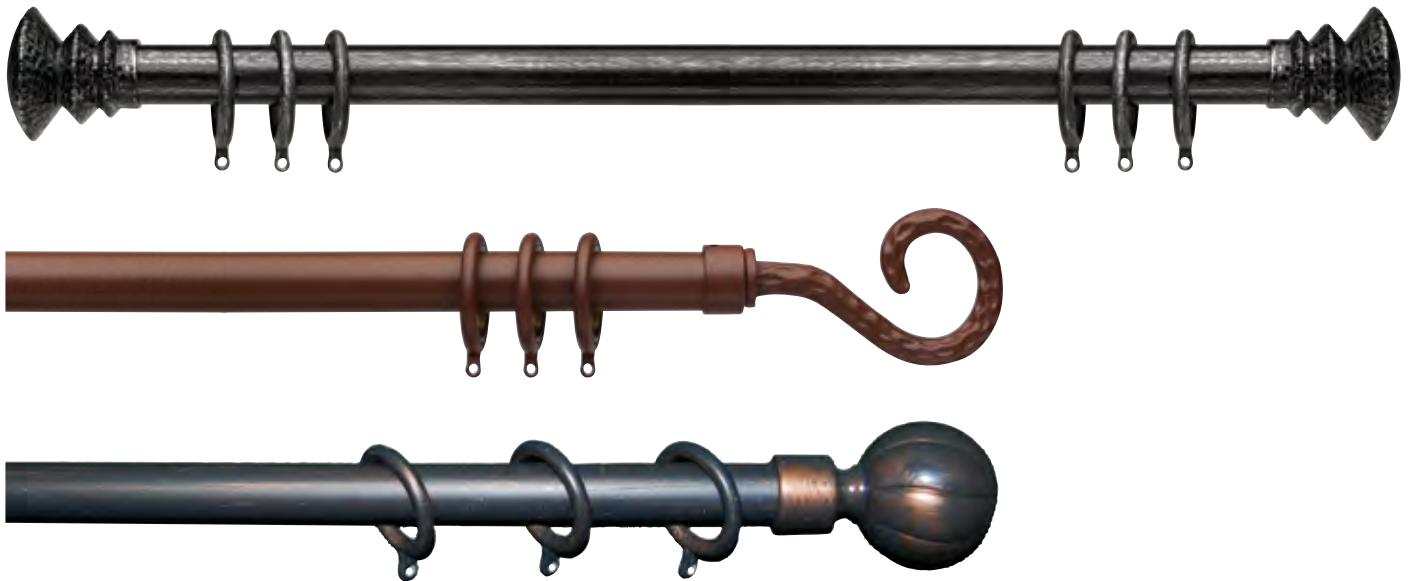

## AVAILABLE FINISHES



BS  
Black Silver

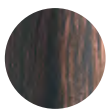

GC  
Grey Copper



SG  
Sand Gold



RS  
Rust



GR  
Graphite Rust



BK  
Black



BR  
Black Brown

## PRODUCT INFORMATION

- Material: Wrought Iron/Steel
- Components material: Wrought Iron/Steel
- Collection style: Classic
- Max length available in one piece: 156"
- Brackets: Recommended every 3-5 feet depending on fabric weight
- Cannot be curved nor bent
- Can be spliced with bracket

## STYLES

- Decorative Rings
- Grommets
- Pocket



# COMPONENTS

## Finials



**ESS820-XX**  
Essen Wrought Iron Pole  
\$8.22/ft.



Profile

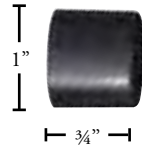

**ESS121-XX**  
End Cap Finial  
\$12.38 ea.

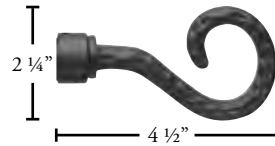

**ESS124-XX**  
Berry Finial  
\$22.46 ea.



**ESS125-XX**  
Caracola Finial  
\$35.55 ea.

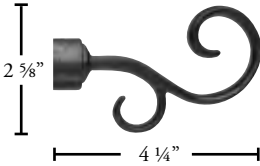

**ESS126-XX**  
Troia Finial  
\$24.85 ea.



**ESS127-XX**  
Marte Finial  
\$22.46 ea.

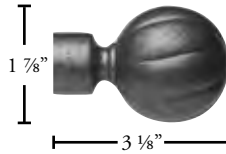

**ESS122-XX**  
Bola Finial  
\$35.57 ea.

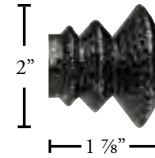

**ESS123-XX**  
Everest Finial  
\$33.42 ea.

## Brackets



**ESS221-XX**  
Lateral Bracket  
\$17.44 ea.



**ESS222-XX**  
Ceiling Bracket  
\$28.72 ea.

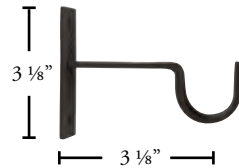

**ESS223-XX**  
York Single Open Bracket  
\$30.20 ea.

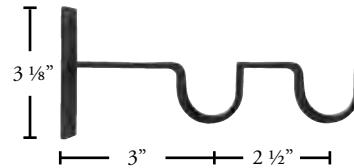

**ESS224-XX**  
York Double Open Bracket  
\$40.11 ea.

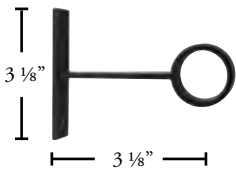

**ESS225-XX**  
York Single Closed Bracket  
\$33.21 ea.

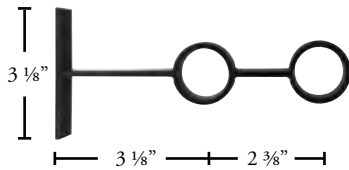

**ESS226-XX**  
York Double Closed Bracket  
\$44.26 ea.

## Other Components

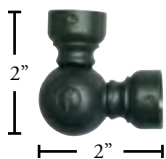

**ESS410-XX**  
Swivel Corner Connector  
\$62.03 ea.

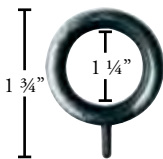

**ESS320-XX**  
Smooth Ring  
\$4.72 ea.



**ESS601**  
Pole Splice  
\$14.78 ea.



For batons see p.127

For more information visit [www.angbejar.com](http://www.angbejar.com)

# TORINO COLLECTION

1 3/16" DECORATIVE WROUGHT IRON



## AVAILABLE FINISHES



BS

Black Silver

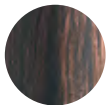

GC

Grey Copper



SG

Sand Gold



RS

Rust



GR

Graphite Rust



BK

Black



BR

Black Brown

## PRODUCT INFORMATION

- Material: Wrought Iron/Steel
- Components material: Wrought Iron/Steel
- Collection style: Classic
- Max length available in one piece: 156"
- Brackets: Recommended every 4-6 feet depending on fabric weight
- Cannot be curved nor bent
- Can be spliced with bracket

## STYLES

- Decorative Rings
- Grommets
- Pocket



# COMPONENTS

## Finials



**TOR830-XX**  
Torino Wrought Iron Pole  
\$11.14/ft.



Profile

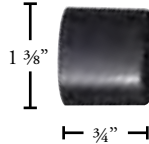

**TOR131-XX**  
End Cap Finial  
\$14.08 ea.

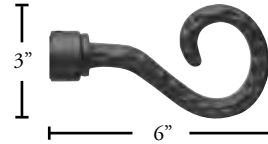

**TOR134-XX**  
Berry Finial  
\$24.96 ea.

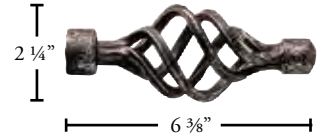

**TOR135-XX**  
Caracola Finial  
\$64.29 ea.

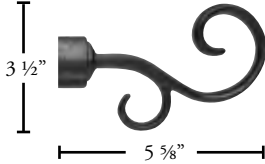

**TOR136-XX**  
Troia Finial  
\$27.60 ea.



**TOR137-XX**  
Marte Finial  
\$24.96 ea.

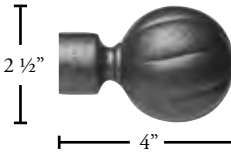

**TOR132-XX**  
Bola Finial  
\$61.56 ea.

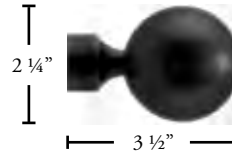

**TOR138-XX**  
Smooth Ball Finial  
\$61.56 ea.

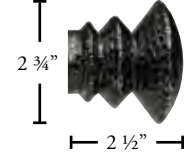

**TOR133-XX**  
Everest Finial  
\$37.14 ea.

## Brackets

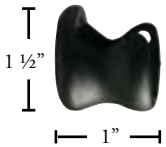

**TOR231-XX**  
Lateral Bracket  
\$18.56 ea.



**TOR232-XX**  
Ceiling Bracket  
\$29.25 ea.

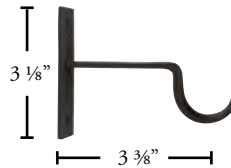

**TOR233-XX**  
York Single Open Bracket  
\$30.20 ea.

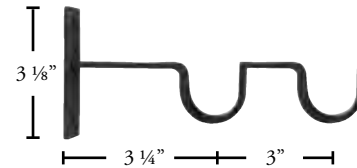

**TOR234-XX**  
York Double Open Bracket  
\$40.25 ea.



**TOR240-XX**  
French Return Bracket  
\$37.29 ea.

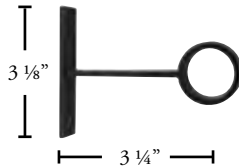

**TOR235-XX**  
York Single Closed Bracket  
\$33.21 ea.

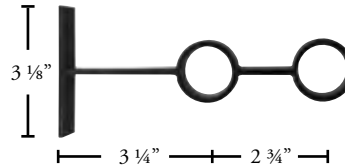

**TOR236-XX**  
York Double Closed Bracket  
\$44.26 ea.

## Other Components



**TOR410-XX**  
Swivel Corner Connector  
\$98.20 ea.

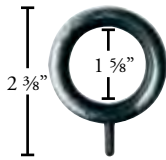

**TOR330-XX**  
Smooth Ring  
\$9.36 ea.



**TOR601**  
Pole Splice  
\$14.78 ea.



For batons see p. 127

For more information visit [www.angbejar.com](http://www.angbejar.com)

# BEACHFRONT COLLECTION

1 1/8" OUTDOOR DECORATIVE METAL



## AVAILABLE FINISHES



**BK**  
Black



**BZ**  
Bronze



**WH**  
White



**SS**  
Stainless Steel

## PRODUCT INFORMATION

- Material: Aluminum
- Components material: Powder Coated Steel
- Collection style: Modern/Contemporary/Classic
- Max length available in one piece: 240"
- Brackets: Recommended every 3-5 feet depending on fabric weight
- Cannot be curved nor bent
- Can be spliced with bracket

## STYLES

- Decorative Rings
- Grommets
- Pocket

## COMPONENTS



**BEA828-XX**  
Beachfront Pole 20'  
\$30.96/ft.



Profile

## Finials



**BEA121-XX**  
End Cap Finial  
\$25.06 ea.

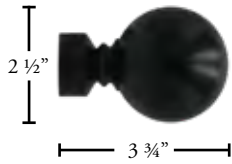

**BEA122-XX**  
Lazio Finial  
\$66.68 ea.

## Brackets

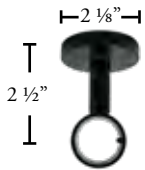

**BEA221-XX**  
Closed Ceiling Bracket  
\$84.48 ea.

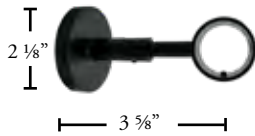

**BEA222-XX**  
Closed Wall Bracket  
\$92.53ea.

## Other Components

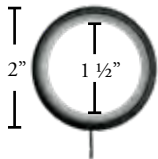

**BEA328-XX**  
Ring w/Eyelet  
\$10.55 ea.

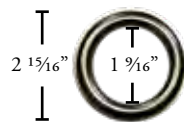

**BEA330-XX**  
#12 Grommet  
\$10.89 ea.



**BEA601**  
Splice  
\$14.78 ea.

# ROMA COLLECTION

1 3/8" DECORATIVE WOOD



## AVAILABLE FINISHES



UN  
Unfinished



WH  
White



ST  
Stone



BK  
Black



HZ  
Hazel



HN  
Honey

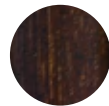

WL  
Walnut



NT  
Natural

## PRODUCT INFORMATION

- Material: Wood
- Components material: Wood
- Collection style: Modern/Contemporary/Classic
- Max length available in one piece: 156"
- Brackets: Recommended every 3-5 feet depending on fabric weight
- Cannot be curved nor bent
- Can be spliced with bracket

## STYLES

- Rings
- Grommets
- Pocket

## COMPONENTS



**ROM835-XX**  
Roma Smooth Wood Pole  
\$9.65/ft.

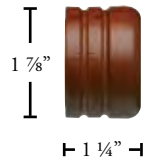

**ROM131-XX**  
End Cap Finial  
\$8.87 ea.

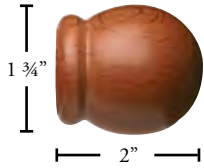

**ROM132-XX**  
Bola Finial  
\$12.51 ea.

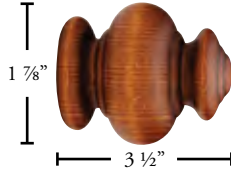

**ROM133-XX**  
Odiseia Finial  
\$30.82 ea.

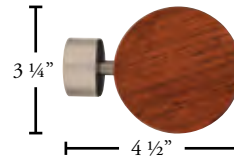

**ROM141-XX**  
Redondo Finial  
\$66.03 ea.

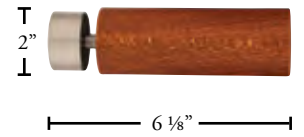

**ROM142-XX**  
Mossa Finial  
\$68.79 ea.

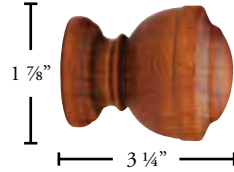

**ROM134-XX**  
Calice Finial  
\$33.42 ea.

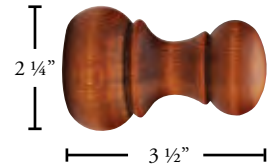

**ROM135-XX**  
Campina Finial  
\$28.93 ea.

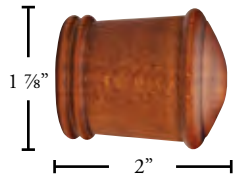

**ROM136-XX**  
Corona Finial  
\$15.69 ea.

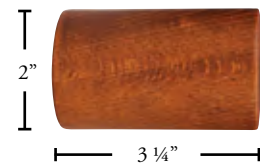

**ROM137-XX**  
Country Finial  
\$33.03 ea.

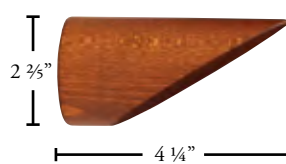

**ROM138-XX**  
Deko Finial  
\$26.33 ea.

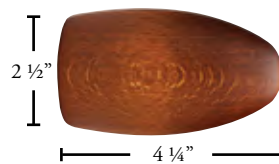

**ROM139-XX**  
Basic Finial  
\$26.33 ea.

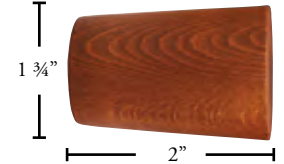

**ROM140-XX**  
Zenith Finial  
\$30.52 ea.

## Brackets

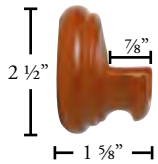

**ROM234-XX**  
Inside Mount Bracket  
\$14.03 ea.

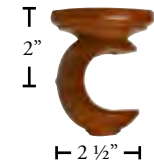

**ROM233-XX**  
Ceiling Bracket  
\$18.62 ea.



**ROM232-XX**  
Classic Open Bracket  
\$22.06 ea.

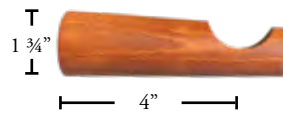

**ROM231-XX**  
Cylinder Bracket  
\$18.53 ea.

## Other Components

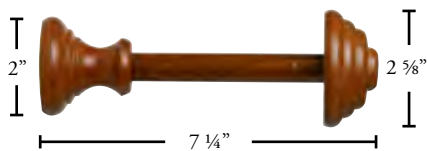

**WHB507-XX**  
Wood Holdback  
\$24.29 ea.

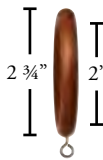

**ROM330-XX**  
Wood Ring w/ Eyelet  
\$3.05 ea.



For batons see p.127

For more information visit [www.angbejar.com](http://www.angbejar.com)

# TOULOUSE COLLECTION

1 3/4" DECORATIVE WOOD



## AVAILABLE FINISHES



DR  
Driftwood



WO  
Weathered Oak



RE  
Redwood



TO  
Tiger Oak



ES  
Espresso

## PRODUCT INFORMATION

- Material: Wood
- Components material: Wood
- Collection style: Modern/Contemporary/Classic
- Max length available in one piece: 96"
- Brackets: Recommended every 3-5 feet depending on fabric weight
- Cannot be curved nor bent
- Can be spliced with bracket

## STYLES

- Rings
- Grommets
- Pocket



## COMPONENTS



**TOL835-XX**  
Smooth Wood Pole  
\$39.43/ft.

## Finials

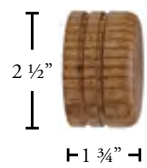

**TOL131-XX**  
End Cap Finial  
\$11.76 ea.



**TOL132-XX**  
Smooth Ball Finial  
\$25.57 ea.



**TOL133-XX**  
Ringed Ball Finial  
\$25.57 ea.



**TOL134-XX**  
Granada Finial  
\$20.14 ea.

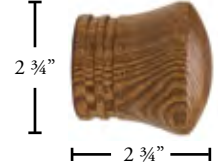

**TOL135-XX**  
Castell Finial  
\$21.19 ea.

## Bracket & Ring



**TOL234-XX**  
Wood Wall Bracket  
\$42.03 ea.

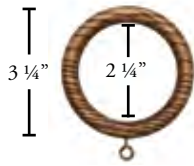

**TOL333-XX**  
Wood Ring  
\$2.94 ea.



For more information visit [www.angbejar.com](http://www.angbejar.com)

# MADRID COLLECTION

## 2" DECORATIVE WOOD



### AVAILABLE FINISHES



UN  
Unfinished



WH  
White



SA  
Sand Gold  
Antiqued



LA  
Leather  
Antiqued



ST  
Stone

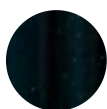

BK  
Black

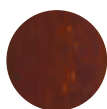

HZ  
Hazel



HN  
Honey

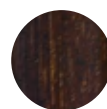

WL  
Walnut



NT  
Natural

### PRODUCT INFORMATION

- Material: Wood
- Components material: Wood
- Collection style: Modern/Contemporary/Classic
- Max length available in one piece: 168"
- Brackets: Recommended every 4-6 feet depending on fabric weight
- Cannot be curved nor bent
- Can be spliced with bracket

### STYLES

- Rings
- Grommets
- Pocket

# COMPONENTS

## Finials



**MAD850-XX**  
Madrid Smooth Pole  
\$18.47/ft. unfinished  
\$20.94/ft. finished  
\$31.37/ft. antiqued



**MAD851-XX**  
Madrid Reeded Pole  
\$20.50/ft. unfinished  
\$26.68/ft. finished

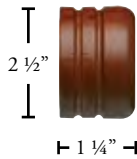

**END151-XX**  
End Cap Finial  
\$12.10 ea. unfinished  
\$15.12 ea. finished  
\$19.96 ea. antiqued

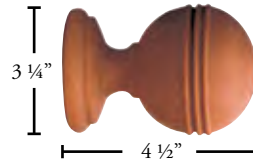

**RIN162-XX**  
Ringed Ball Finial  
\$32.13 ea. unfinished  
\$40.85 ea. finished  
\$58.26 ea. antiqued



**WIN163-XX**  
Windsor Finial  
\$56.60 ea. unfinished  
\$68.96 ea. finished  
\$74.38 ea. antiqued

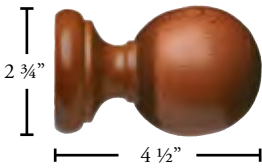

**SMO161-XX**  
Smooth Ball Finial  
\$30.86 ea. unfinished  
\$40.60 ea. finished

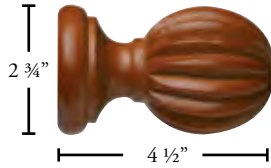

**FLU152-XX**  
Fluted Ball Finial  
\$46.32 ea. unfinished  
\$57.04 ea. finished

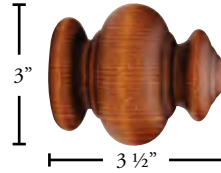

**ODI153-XX**  
Odiseia Finial  
\$32.74 ea. unfinished  
\$48.61 ea. finished

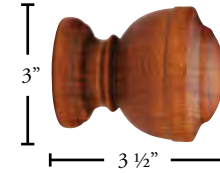

**CAL154-XX**  
Calice Finial  
\$34.07 ea. unfinished  
\$49.85 ea. finished

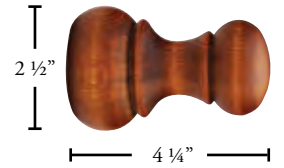

**CAM155-XX**  
Campina Finial  
\$43.31 ea. unfinished  
\$64.41 ea. finished

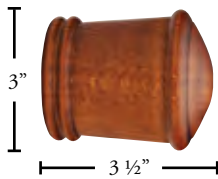

**COR156-XX**  
Corona Finial  
\$31.89 ea. unfinished  
\$47.44 ea. finished



**TUD165-XX**  
Tudor Finial  
\$52.99 ea. unfinished  
\$58.62 ea. finished

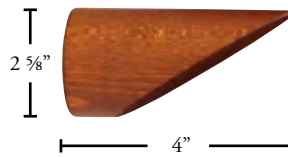

**DEK158-XX**  
Deka Finial  
\$39.44 ea. unfinished  
\$58.57 ea. finished

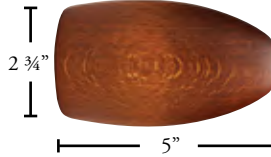

**BAS159-XX**  
Basic Finial  
\$39.44 ea. unfinished  
\$58.57 ea. finished



**TRA164-XX**  
Traditional Finial  
\$28.37 ea. unfinished  
\$34.52 ea. finished  
\$39.43 ea. antiqued

## Brackets

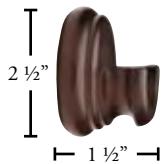

**MAD254-XX**  
Inside Mount Bracket  
\$26.04 ea. unfinished  
\$32.11 ea. finished  
\$46.43 ea. antiqued

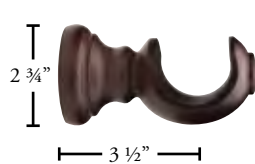

**MAD253-XX**  
Euro Wood Bracket  
\$22.46 ea. unfinished  
\$28.38 ea. finished  
\$43.65 ea. antiqued

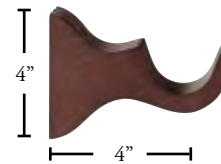

**MAD251-XX**  
Wood Bracket  
\$34.03 ea. unfinished  
\$42.03 ea. finished  
\$61.52 ea. antiqued



**MAD252-XX**  
Extended Wood Bracket  
\$61.70 ea. unfinished  
\$76.19 ea. finished

## Other Components

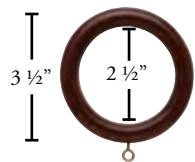

**MAD350-XX**  
Wood Ring w/ Eyelet  
\$4.40 ea. unfinished  
\$5.93 ea. finished  
\$9.73 ea. antiqued



**WHB504-UN**  
Rosette Shield  
\$25.79 ea.



For batons see p.127

For more information visit [www.angbejar.com](http://www.angbejar.com)

# VALENCIA COLLECTION

2 3/4" DECORATIVE WOOD



## AVAILABLE



UN  
Unfinished

## CUSTOM FINISHES\*



WH  
White



BK  
Black

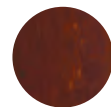

HZ  
Hazel



HN  
Honey

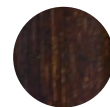

WL  
Walnut



NT  
Natural

## PRODUCT INFORMATION

- Material: Wood
- Components material: Wood
- Collection style: Classic
- Max length available in one piece: 156"
- Brackets: Recommended every 3-5 feet depending on fabric weight
- Cannot be curved nor bent
- Can be spliced with bracket

## STYLES

- Rings
- Grommets
- Pocket

\*Custom finishes available at an additional cost. Call for a quote.

## COMPONENTS



**VAL870-XX**  
Valencia Smooth Pole  
\$32.17/ft.



**VAL871-XX**  
Valencia Reeded Pole  
\$33.86/ft.

## Finials

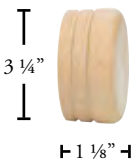

**END171-XX**  
End Cap Finial  
\$14.84 ea.



**FLU172-XX**  
Fluted Ball Finial  
\$66.45 ea.

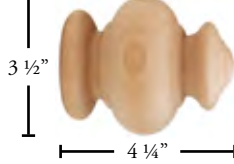

**ODI173-XX**  
Odiseia Finial  
\$48.77 ea.

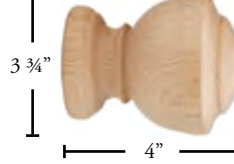

**CAL174-XX**  
Calice Finial  
\$50.09 ea.



**CAM175-XX**  
Campina Finial  
\$63.49 ea.

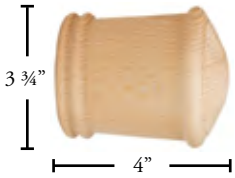

**COR176-XX**  
Corona Finial  
\$47.59 ea.

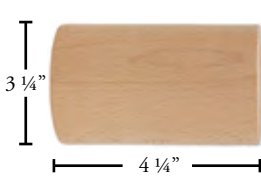

**COU177-XX**  
Country Finial  
\$56.00 ea.

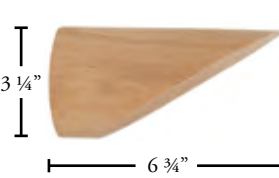

**DEK178-XX**  
Deka Finial  
\$58.88 ea.

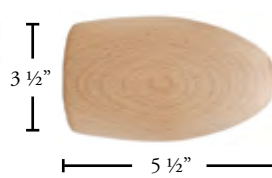

**BAS179-XX**  
Basic Finial  
\$58.88 ea.

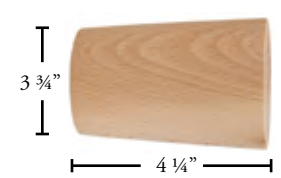

**ZEN180-XX**  
Zenith Finial  
\$57.56 ea.



**SMO181-XX**  
Smooth Ball Finial  
\$49.00 ea.

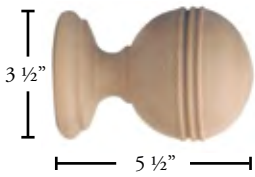

**RIN182-XX**  
Ringed Ball Finial  
\$51.02 ea.



**WIN183-XX**  
Windsor Finial  
\$90.78 ea.

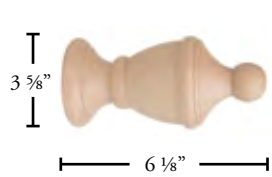

**TRA184-XX**  
Traditional Finial  
\$68.13 ea.

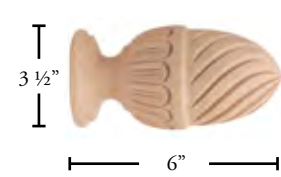

**TUD185-XX**  
Tudor Finial  
\$62.88 ea.

## Brackets & Other Components

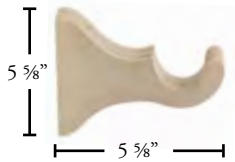

**VAL271-XX**  
Wood Bracket  
\$36.87 ea.

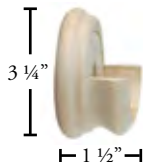

**VAL274-XX**  
Mount Bracket  
\$41.50 ea.

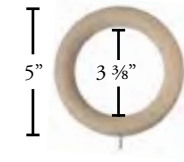

**VAL370-XX**  
Wood Ring w/eyelet  
\$17.33 ea.



For holdbacks see p. 128



For batons see p.127

For more information visit [www.angbejar.com](http://www.angbejar.com)



# Other Products & Services

***Get what you need, when you need it.*** In addition to our wide range of drapery hardware tracks, rails, and pole sets, we offer a great selection of regular batons, decorative batons, holdbacks, and tiebacks to complete your design.

- Batons – Available in a variety of styles and materials including fiberglass, acrylic, aluminum, wood, metal, and wrought iron. We also carry fiberglass and acrylic ADA batons.
- Holdbacks – Available in seven styles. Individually sold or in bulk.
- Tiebacks – Our line of Italian tiebacks uses magnets to hold the drapery. There is no need to drill holes in the walls. Our decorative magnetic tiebacks come in six styles and multiple color options.
- *Decorative Acrylic Batons* in 7 different finishes.
- Other workroom supplies are also available for purchase. No need to order in bulk. AngBéjar has you covered.

AngBéjar

# BATONS

## FIBERGLASS AND ACRYLIC



### ½" Acrylic Baton with Snap

- ABA36S-CL** (36")  
\$9.53 ea.
- ABA48S-CL** (48")  
\$15.42 ea.
- ABA60S-CL** (60")  
\$20.64 ea.
- ABA72S-CL** (72")  
\$27.78 ea.

### ½" Acrylic Baton with Adaptor

- ABA36A-CL** (36")  
\$9.53 ea.
- ABA48A-CL** (48")  
\$15.42 ea.
- ABA60A-CL** (60")  
\$20.64 ea.
- ABA72A-CL** (72")  
\$27.78 ea.



### ½" Acrylic Fluted Baton with Snap

- FABA36S-CL** (36")  
\$9.53 ea.
- FABA48S-CL** (48")  
\$17.80 ea.
- FABA60S-CL** (60")  
\$20.87 ea.
- FABA72S-CL** (72")  
\$27.78 ea.

### ½" Acrylic Fluted Baton with Adaptor

- FABA36A-CL** (36")  
\$9.53 ea.
- FABA48A-CL** (48")  
\$17.80 ea.
- FABA60A-CL** (60")  
\$20.87 ea.
- FABA72A-CL** (72")  
\$27.78 ea.



### ADA Acrylic Baton with Adaptor

- ADA48A-CL** (48")  
\$49.67 ea.
- ADA60A-CL** (60")  
\$57.49 ea.
- ADA72A-CL** (72")  
\$72.46 ea.



### ADA Fiberglass Baton with Adaptor

- FADA48A-WH** (48")  
\$53.58 ea.
- FADA60A-WH** (60")  
\$61.92 ea.
- FADA72A-WH** (72")  
\$74.79 ea.
- FADA84A-WH** (84")  
\$81.53 ea.



### ½" Aluminum Heavy Duty Baton

- MBA36S-XX** (36")  
\$64.90 ea.
- MBA48S-XX** (48")  
\$78.30 ea.
- MBA60S-XX** (60")  
\$94.90 ea.
- MBA72S-XX** (72")  
\$113.45 ea.
- MBA84S-XX** (84")  
\$127.60 ea.
- MBA96S-XX** (96")  
\$142.55 ea.

### Available Colors

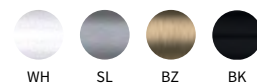

### ¾" Fiberglass Baton with Snap

- FBA30S-WH** (30")  
\$6.12 ea.
- FBA36S-WH** (36")  
\$6.58 ea.
- FBA48S-WH** (48")  
\$8.51 ea.
- FBA60S-WH** (60")  
\$11.91 ea.
- FBA72S-WH** (72")  
\$15.88 ea.
- FBA84S-WH** (84")  
\$20.98 ea.
- FBA96S-WH** (96")  
\$26.20 ea.

### ¾" Fiberglass Baton with Adaptor

- FBA30A-WH** (30")  
\$6.12 ea.
- FBA36A-WH** (36")  
\$6.58 ea.
- FBA48A-WH** (48")  
\$8.51 ea.
- FBA60A-WH** (60")  
\$11.91 ea.
- FBA72A-WH** (72")  
\$15.88ea.
- FBA84A-WH** (84")  
\$20.98 ea.
- FBA96A-WH** (96")  
\$26.20 ea.



## METAL BATONS



**Metal Baton 40"**  
**MBA140-XX**  
\$87.73 ea.

**Available Finishes**

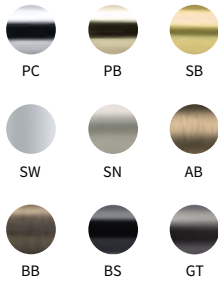

**Round Metal Baton  
Stainless Steel 40"**  
**MBA240-SS**  
\$92.26 ea.

**Square Metal Baton  
Stainless Steel 40"**  
**MBA340-SS**  
\$97.14 ea.

**Available Finishes**



**Wrought Iron Baton  
40"**  
**IBA440-XX**  
\$78.01 ea.

**Available Finishes**

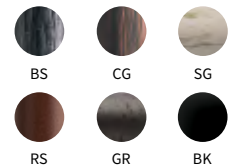

**Slim Metal Baton**  
**MBA736-XX (36")**  
\$63.62 ea.  
**MBA748-XX (48")**  
\$76.83 ea.  
**MBA760-XX (60")**  
\$84.94 ea.  
**MBA760-XX (72")**  
\$106.18 ea.

**Available Finishes**

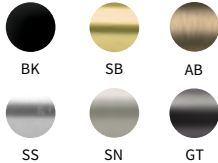

**Aluminum Baton  
with Snap or Adaptor**

**ALB36S-XX (36")**  
**ALB36A-XX (36")**  
\$116.90 ea.  
**ALB48S-XX (48")**  
**ALB48A-XX (48")**  
\$18.88 ea.

**Available Colors**



## DECORATIVE ACRYLIC



**Decorative Acrylic  
Baton**

**DAB36S-XX (36")**  
**DAB36A-XX (36")**  
\$43.55 ea.  
**DAB48S-XX (48")**  
**DAB48A-XX (48")**  
\$49.44 ea.  
**DAB60S-XX (60")**  
**DAB60A-XX (60")**  
\$54.66 ea.  
**DAB72S-XX (72")**  
**DAB72A-XX (72")**  
\$61.80 ea.

**Available Finishes**

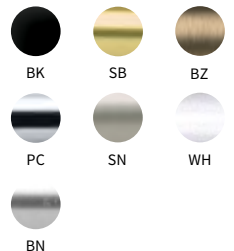

## WOOD BATONS



**Wood Baton 40"**  
**WBA540-XX**  
\$20.65 ea. unfinished  
\$25.42 ea. finished  
\$47.33 ea. antiqued

**Available Finishes**



**Wood Baton 40"**  
**WBA640-XX**  
\$20.65 ea. unfinished  
\$25.42 ea. finished  
\$47.33 ea. antiqued

**Available Finishes**



For more information visit [www.angbejar.com](http://www.angbejar.com)

# HOLDBACKS

## WOOD HOLDBACKS



**WHB507-XX**  
Wood Holdback  
\$24.29 ea.



**WHB504-UN**  
Rosetta Shield  
\$25.79 ea.

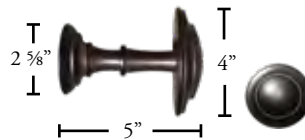

**WHB505-XX**  
Round Wood Holdback  
\$49.78 ea.

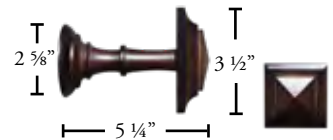

**WHB506-XX**  
Square Wood Holdback  
\$49.78 ea.

## AVAILABLE FINISHES



UN



WH



BK



HZ



HN

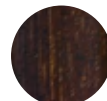

WL



NT

## METAL HOLDBACKS

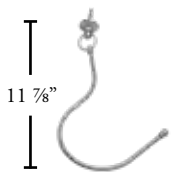

**MHB512-XX**  
Metal Swing Holdback  
\$84.44 ea.

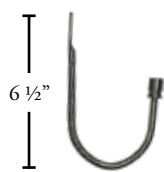

**MHB511-XX**  
Metal Cylinder Holdback  
\$52.45 ea.

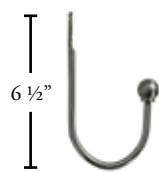

**MHB510-XX**  
Metal Ball Holdback  
\$52.45 ea.

## AVAILABLE FINISHES

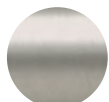

SN



SS



PC



GT



BK



BZ

# TIEBACKS

## MAGNETIC TIEBACKS

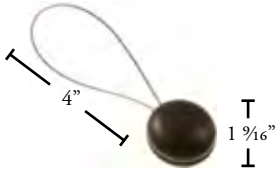

**TIE520-XX**  
Donato Tieback  
\$36.17 ea.  
Available Finishes

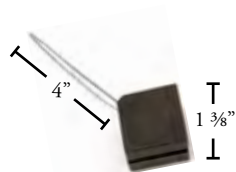
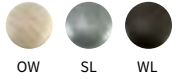

**TIE521-XX**  
Lia Tieback  
\$36.17 ea.  
Available Finishes

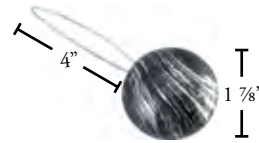

**TIE522-XX**  
Dante Tieback  
\$37.99 ea.  
Available Finishes

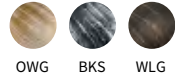

**TIE523-XX**  
Ofir Tieback  
\$47.74 ea.  
Available Finishes

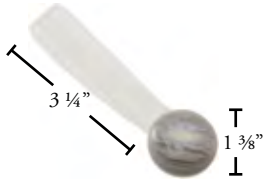

**TIE524-XX**  
Elia Tieback  
\$39.58 ea.  
Available Finishes



**TIE525-XX**  
Ava Tieback  
\$45.13 ea.  
Available Finishes

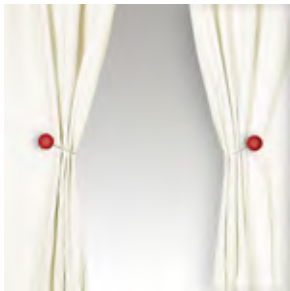
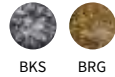

For more information visit [www.angbejar.com](http://www.angbejar.com)

# SNAP TAPE



**RSTP03-WH**  
1" Ripplefold\* Snap Tape  
4 1/4" OC spacing  
\$4.52/yd. 100yds./roll

**RSTP01-BK**  
1" Ripplefold Snap Tape  
4 1/4" OC spacing  
\$4.93/yd. 100yds./roll

**RSTP01-CL**  
1" Ripplefold Snap Tape  
4 1/4" OC spacing  
\$4.93/yd. 100yds./roll

**RSTP07-WH**  
Accordiafold Snap Tape  
7 1/2" OC spacing  
\$5.90/yd. 100yds./roll

**RSTP08-WH**  
Accordiafold Snap Tape  
8 1/2" OC spacing  
\$5.90/yd. 100yds./roll

**RSTP10-WH**  
Accordiafold Snap Tape  
10" OC spacing  
\$5.90/yd. 100yds./roll

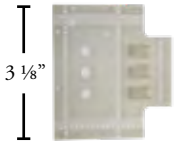

**STI09-WH**  
Stiffener LG  
\$1.01 ea.



**STI01-WH**  
Small Stiffener for sheers  
\$0.85 ea.



**FWT36-CL**  
FlexWave Tape  
\$3.76 yd. 100 yds./roll



**FWP37-WH**  
FlexWave Pendant for  
Ripplefold Carriers  
\$0.48 ea. 500/bag



**FWH38-WH**  
FlexWave Hook  
\$0.25 ea.

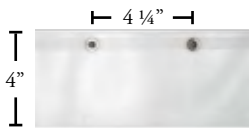

**RSTP04-CL**  
4" Translucent Ripplefold  
Snap Tape  
\$6.52/yd. 50yds./roll

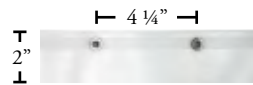

**RSTP02-CL**  
2" Translucent Ripplefold  
Snap Tape  
\$5.78/yd. 50yds./roll



**BWE05-WH**  
Braided Lead  
Weight Roll 5/32"  
\$365.20/roll with 140 yds.



\*Ripplefold is a trademark of Kirsch

# GROMMETS



**GROM12-XX**  
Grommet #12  
\$4.90 ea.



**SB**  
Satin Brass



**AB**  
Antique Brass



**BZ**  
Bronze



**BK**  
Black



**GT**  
Graphite



**SN**  
Satin Nickel



**CR**  
Chrome



**SS**  
Stainless Steel

For more information visit [www.angbejar.com](http://www.angbejar.com)

# CURVES & BENDS

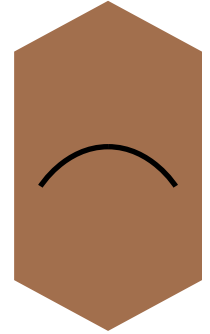
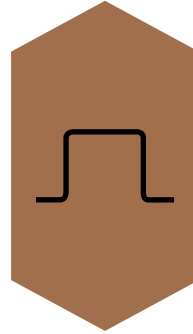
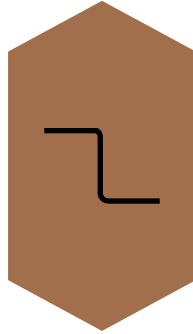
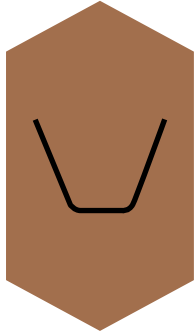
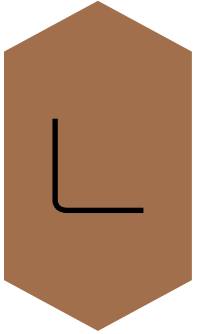

## TRACK SYSTEMS

- B3 Series p.4
- D3 Series p.6
- B9 Series p.8
- C6 Series p.16
- M6FX Series p.20
- M6SX Series p.22
- M6DX Series p.24

Starting at:

**\$59**

## DECORATIVE RAILS

- Urban Collection p. 38
- Amsterdam Collection p.40
- Barcelona Collection p.42
- Munich Collection\* p.44
- Lyon Collection\* p.46
- Berlin Collection\* p.48
- Seine Collection p.50

Starting at:

**\$95**

**Template is required. Additional crating charges may apply. Discounts may not apply. Call for a quote.**

\*Polished Chrome finish excluded.

## RIPPLEFOLD CARRIER COUNT

### 60% Fullness - 2<sup>5</sup>/<sub>8</sub>" spacing

Track size	14 - 19	20 - 24	25 - 30	31 - 35	36 - 40	41 - 45	46 - 51	52 - 56	57 - 61	62 - 66
<b># Carriers</b>	<b>8</b>	<b>10</b>	<b>12</b>	<b>14</b>	<b>16</b>	<b>18</b>	<b>20</b>	<b>22</b>	<b>24</b>	<b>26</b>
67 - 72	73 - 77	78 - 82	83 - 87	88 - 93	94 - 98	99 - 103	104 - 108	109 - 114	115 - 119	120 - 124
<b>28</b>	<b>30</b>	<b>32</b>	<b>34</b>	<b>36</b>	<b>38</b>	<b>40</b>	<b>42</b>	<b>44</b>	<b>46</b>	<b>48</b>
125 - 129	130 - 135	136 - 140	141 - 145	146 - 150	151 - 156	157 - 161	162 - 166	167 - 171	172 - 176	177 - 182
<b>50</b>	<b>52</b>	<b>54</b>	<b>56</b>	<b>58</b>	<b>60</b>	<b>62</b>	<b>64</b>	<b>66</b>	<b>68</b>	<b>70</b>
183 - 187	188 - 192	193 - 197	198 - 203	204 - 208	209 - 214	215 - 219	220 - 224	225 - 229	230 - 235	236 - 240
<b>72</b>	<b>74</b>	<b>76</b>	<b>78</b>	<b>80</b>	<b>82</b>	<b>84</b>	<b>86</b>	<b>88</b>	<b>90</b>	<b>92</b>

### 80% Fullness - 2<sup>3</sup>/<sub>8</sub>" spacing

Track size	14 - 17	18 - 22	23 - 27	28 - 32	33 - 36	37 - 41	42 - 46	47 - 51	52 - 55	56 - 60
<b># Carriers</b>	<b>8</b>	<b>10</b>	<b>12</b>	<b>14</b>	<b>16</b>	<b>18</b>	<b>20</b>	<b>22</b>	<b>24</b>	<b>26</b>
61 - 65	66 - 70	71 - 74	75 - 79	80 - 84	85 - 89	90 - 93	94 - 98	99 - 103	104 - 108	109 - 112
<b>28</b>	<b>30</b>	<b>32</b>	<b>34</b>	<b>36</b>	<b>38</b>	<b>40</b>	<b>42</b>	<b>44</b>	<b>46</b>	<b>48</b>
113 - 117	118 - 122	123 - 127	128 - 131	132 - 136	137 - 141	142 - 146	147 - 150	151 - 155	156 - 160	161 - 165
<b>50</b>	<b>52</b>	<b>54</b>	<b>56</b>	<b>58</b>	<b>60</b>	<b>62</b>	<b>64</b>	<b>66</b>	<b>68</b>	<b>70</b>
166 - 169	170 - 174	175 - 179	180 - 184	185 - 188	189 - 193	194 - 198	199 - 203	204 - 208	209 - 212	213 - 217
<b>72</b>	<b>74</b>	<b>76</b>	<b>78</b>	<b>80</b>	<b>82</b>	<b>84</b>	<b>86</b>	<b>88</b>	<b>90</b>	<b>92</b>

### 100% Fullness - 2<sup>1</sup>/<sub>8</sub>" spacing

Track size	12 - 16	17 - 20	21 - 24	25 - 28	29 - 32	33 - 37	38 - 41	42 - 45	46 - 50	51 - 54
<b># Carriers</b>	<b>8</b>	<b>10</b>	<b>12</b>	<b>14</b>	<b>16</b>	<b>18</b>	<b>20</b>	<b>22</b>	<b>24</b>	<b>26</b>
55 - 58	59 - 62	63 - 66	67 - 71	72 - 75	76 - 79	80 - 84	85 - 88	89 - 92	93 - 96	97 - 101
<b>28</b>	<b>30</b>	<b>32</b>	<b>34</b>	<b>36</b>	<b>38</b>	<b>40</b>	<b>42</b>	<b>44</b>	<b>46</b>	<b>48</b>
102 - 105	106 - 109	110 - 113	114 - 118	119 - 122	123 - 126	127 - 130	131 - 136	137 - 139	140 - 143	144 - 147
<b>50</b>	<b>52</b>	<b>54</b>	<b>56</b>	<b>58</b>	<b>60</b>	<b>62</b>	<b>64</b>	<b>66</b>	<b>68</b>	<b>70</b>
148 - 152	153 - 156	157 - 160	161 - 164	165 - 168	169 - 173	174 - 177	178 - 181	182 - 186	187 - 190	191 - 194
<b>72</b>	<b>74</b>	<b>76</b>	<b>78</b>	<b>80</b>	<b>82</b>	<b>84</b>	<b>86</b>	<b>88</b>	<b>90</b>	<b>92</b>

### 120% Fullness - 1<sup>7</sup>/<sub>8</sub>" spacing

Track size	11 - 14	15 - 18	19 - 21	22 - 25	26 - 29	30 - 33	34 - 36	37 - 40	41 - 44	45 - 48
<b># Carriers</b>	<b>8</b>	<b>10</b>	<b>12</b>	<b>14</b>	<b>16</b>	<b>18</b>	<b>20</b>	<b>22</b>	<b>24</b>	<b>26</b>
49 - 51	52 - 55	56 - 59	60 - 63	64 - 66	67 - 70	71 - 74	75 - 78	79 - 81	82 - 85	86 - 89
<b>28</b>	<b>30</b>	<b>32</b>	<b>34</b>	<b>36</b>	<b>38</b>	<b>40</b>	<b>42</b>	<b>44</b>	<b>46</b>	<b>48</b>
90 - 93	94 - 96	97 - 100	101 - 104	105 - 108	109 - 111	112 - 115	116 - 119	120 - 123	124 - 126	127 - 130
<b>50</b>	<b>52</b>	<b>54</b>	<b>56</b>	<b>58</b>	<b>60</b>	<b>62</b>	<b>64</b>	<b>66</b>	<b>68</b>	<b>70</b>
131 - 134	135 - 138	139 - 141	142 - 145	146 - 149	150 - 153	154 - 156	157 - 160	161 - 164	165 - 168	169 - 171
<b>72</b>	<b>74</b>	<b>76</b>	<b>78</b>	<b>80</b>	<b>82</b>	<b>84</b>	<b>86</b>	<b>88</b>	<b>90</b>	<b>92</b>

\* All track sizes are in inches. Count does not include masters.

\*\* For stack back multiply number of carriers x 0.55

For more information visit [www.angbejar.com](http://www.angbejar.com)

# AngBéjar

DRAPERY HARDWARE

 340 N Erwin St.  
Cartersville, GA  
30120

 P. 678.721.1985  
F. 678.721.1982

 [info@angbejar.com](mailto:info@angbejar.com)

 [www.angbejar.com](http://www.angbejar.com)